

8610C Valco Valve Installation

January 2014

The SRI Model 8610C chassis can mount up to two Valco electrically operated gas sampling valves (GSV).

Typical Valco valve mounted in valve oven.



The area to the left of the column oven has pre-punched holes for the valve and also the valve oven.

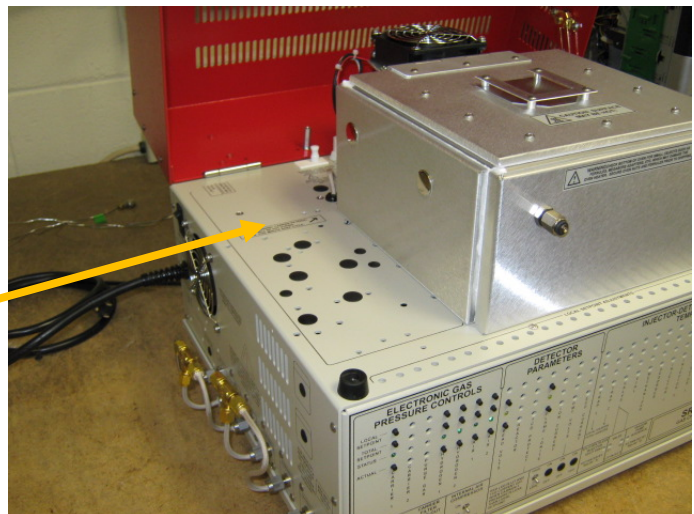
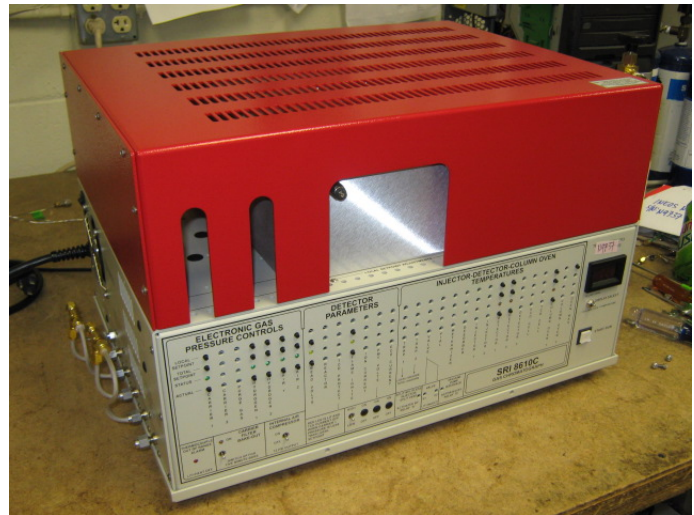

Remove the six (6) phillips head screws holding the bottom cover of the GC

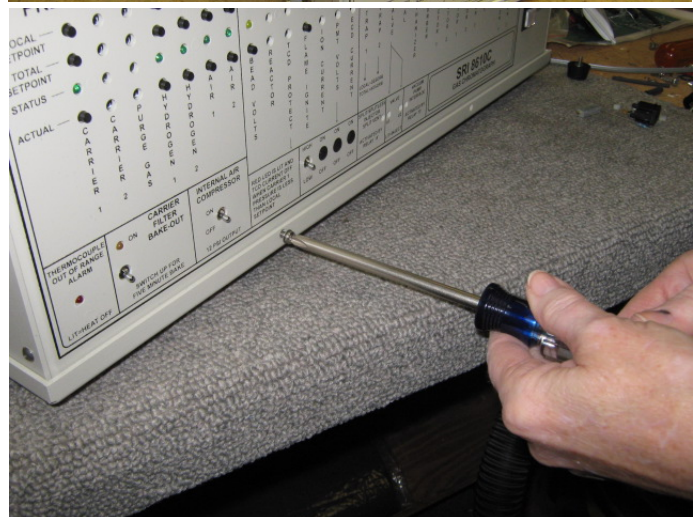

SRI Tech Support: 310-214-5092

8610C Valco Valve Installation

January 2014

Remove the GC's front panel. There are two rubber bumpers in the left and right front corner, plus eight (8) hex head screws which will require a 5/64" hex head wrench.



Tilt the GC on its back to expose the inside, and lift the front panel up and away to expose the display board.

Remove the phone cables from the jacks on the display board. They are labelled, but take a photo or make good notes so you know which cable connects to which jack.

The circuit to control the valve oven heater must be added to this board.

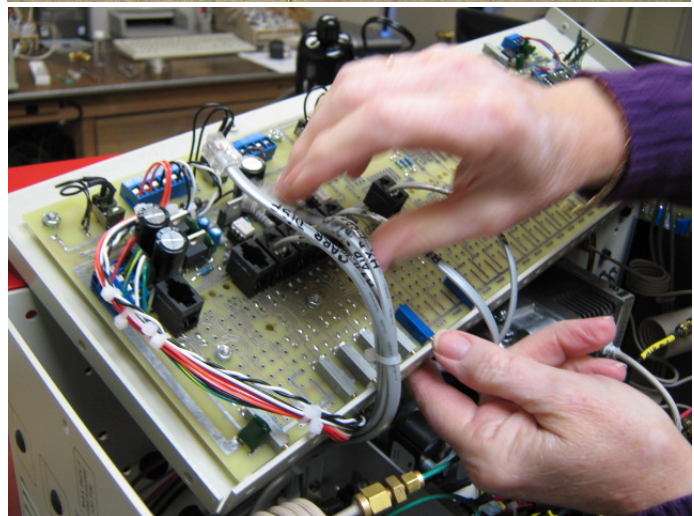
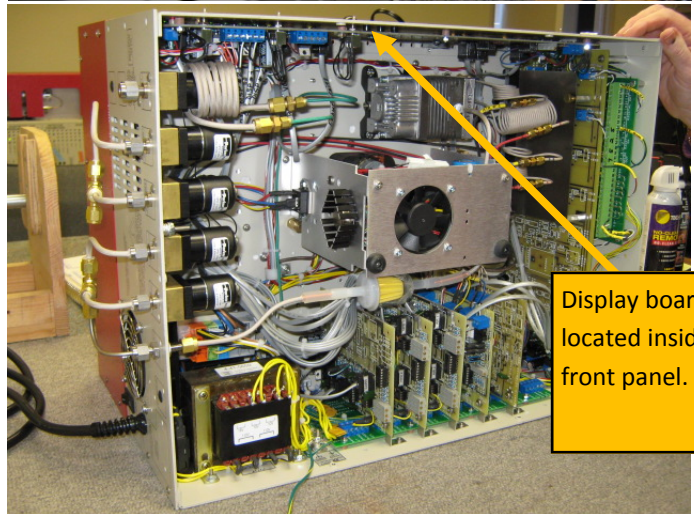
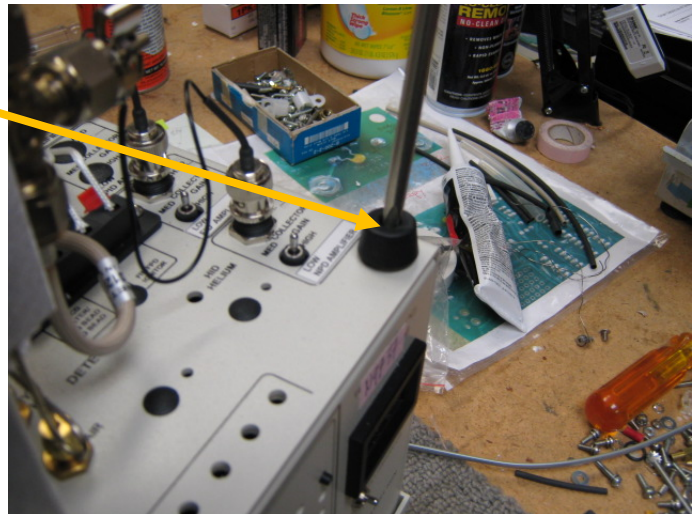

SRI Tech Support: 310-214-5092

8610C Valco Valve Installation

January 2014

Note that there will already be several similar identical heater circuits for the detector heat, injector heat etc already soldered to the display board.

Remove the display board from the front panel using a 5/16" nut driver. There are twelve (12) #6 nuts and lock washers to remove. Use a needle nose plier to remove the lock washers. Careful, since its easy to drop the nuts and washers into the GC if you are not careful.

There are also 12 fiber spacers under the board, which are also easy to lose/drop. Take the spacers off temporarily so they don't fall off during the soldering process.

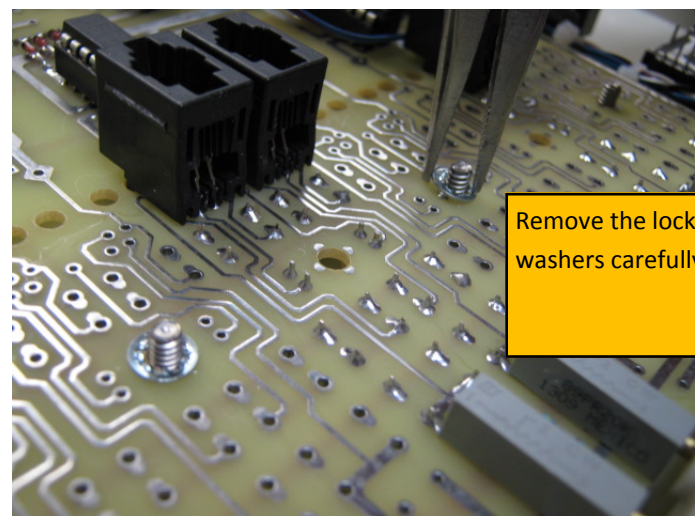
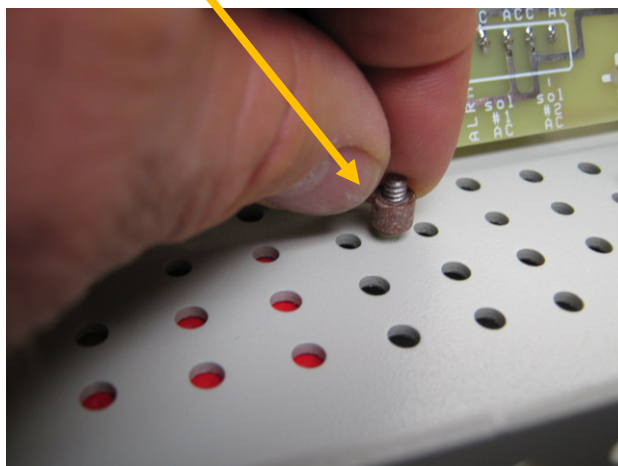
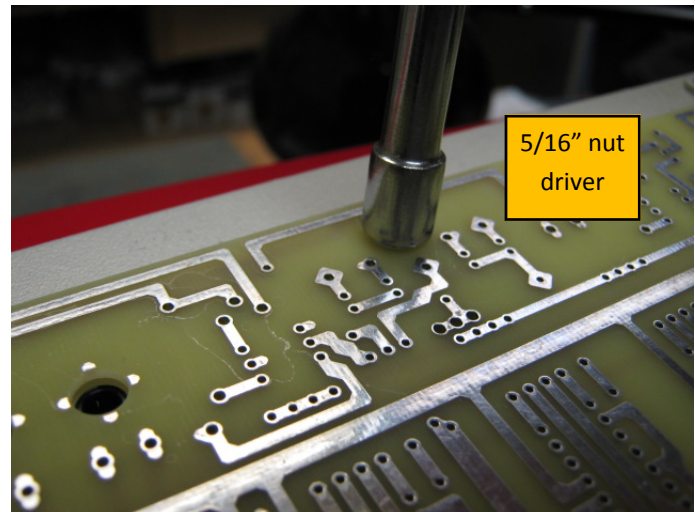
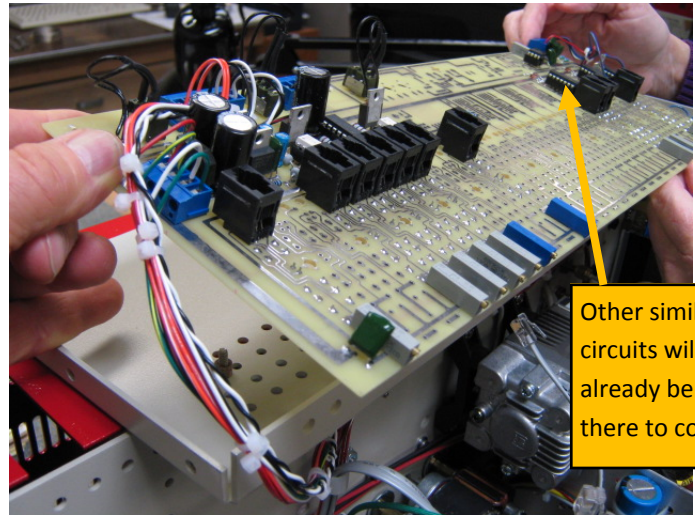

SRI Tech Support: 310-214-5092

8610C Valco Valve Installation

January 2014

The heater circuit on the display board consists of 3 pushbutton switches, a LED, a 20K potentiometer (pot) and a 100K resistor.

There is also a supervisory chip (LM324) and two diodes (1N914) which activates the alarm if the heater temperature is not between 5 and 425C.

The display board has places for 16 identical heater circuits, so the components can actually be mounted in any one of the available spots. If you are installing the first valve, it makes sense to mount the components in the spot which is pre-labelled "Valve 1" (VAL1).

Start by soldering the phone jack in place. Note that the jack is on the opposite side of the board from the pushbuttons. Compare the location of the components with the identical circuits already mounted on the board to control the detector heat, injector heat etc.

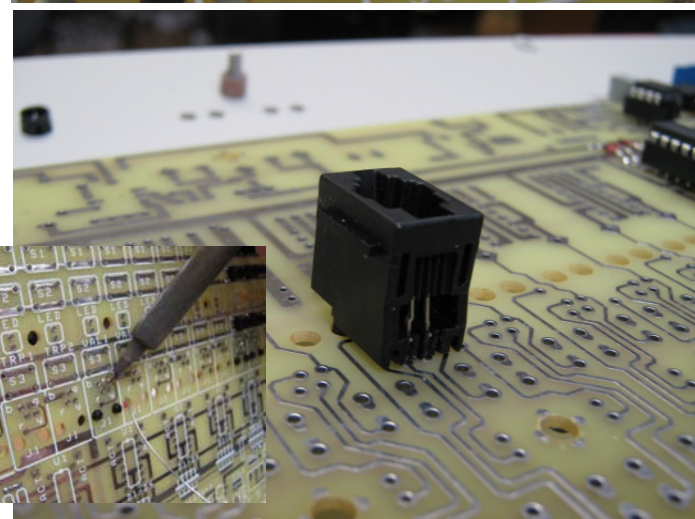
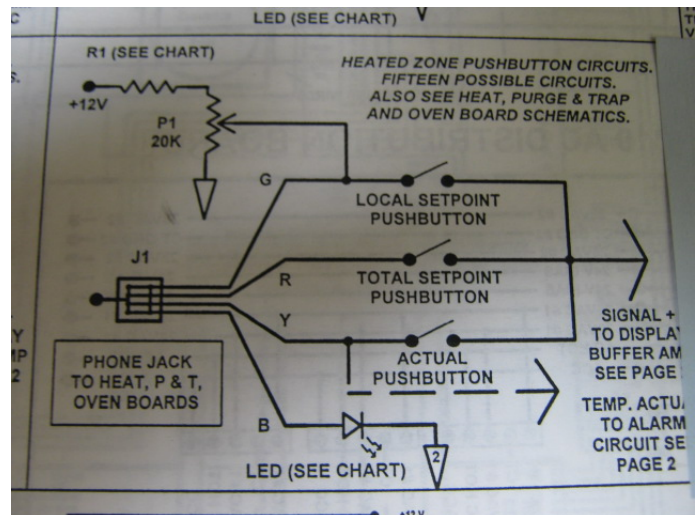

SRI Tech Support: 310-214-5092

8610C Valco Valve Installation

January 2014

Solder the (3) pushbuttons in place. Try to align the buttons so they are perfectly straight. If they are cocked to an angle, the buttons may not fit correctly when all is re-assembled.

Solder the LED and spacer in place. The LED has two legs. The longer leg is the (+) positive leg and should go into the upper of the two holes.

Solder in the pot and resistor. The pot is how the temperature of the valve oven is adjusted. The resistor limits the maximum heat setting that the pot can be adjusted to, in this case about 200C.

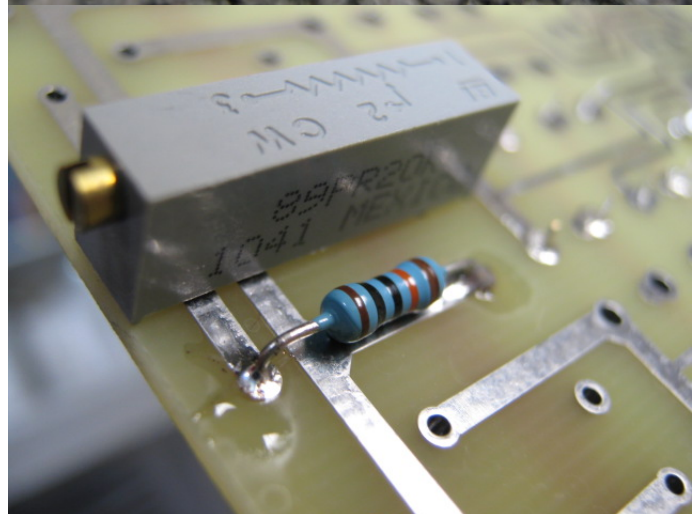
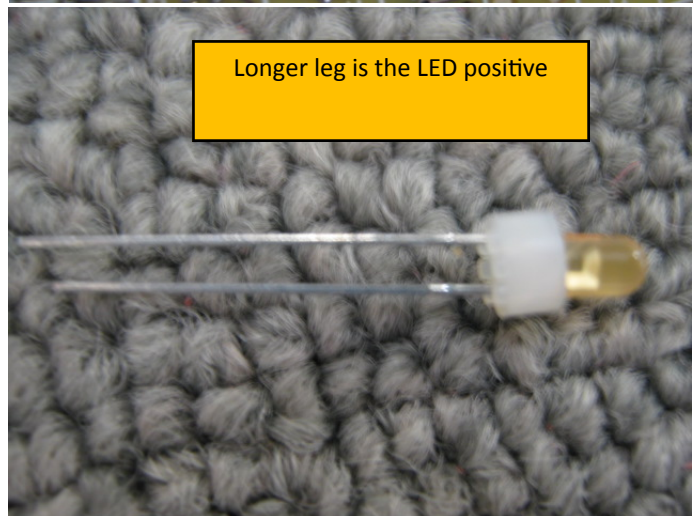
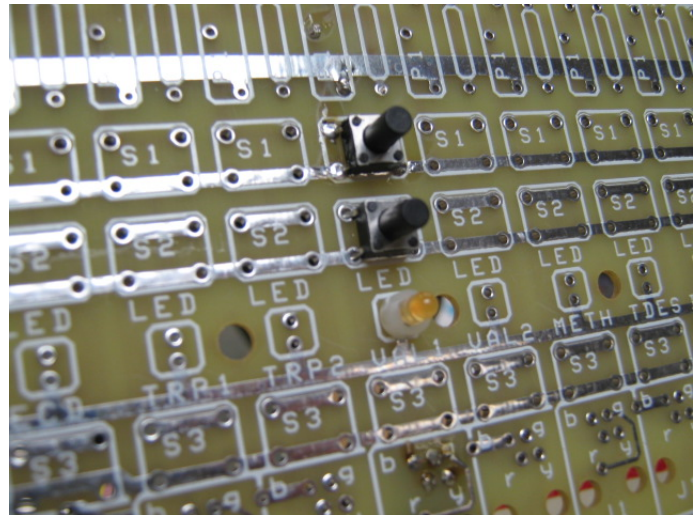

SRI Tech Support: 310-214-5092

8610C Valco Valve Installation

January 2014

Solder in the 14 pin chip socket and then press in the LM324 chip once the socket has been already soldered in place. The chip just presses into the socket. No solder is applied to the chip itself. Note that the chip has a dimple or semi-circular mark on one end. Its important that the chip be inserted in the correct orientation.

Solder in the two 1N914 diodes. Bend the legs and note that each diode has a black band painted on one end. Note which direction the black band must face when soldered in.

The LM324 chip has a left side and a right side.

Where two heater circuits are installed side by side, both sides of the LM324

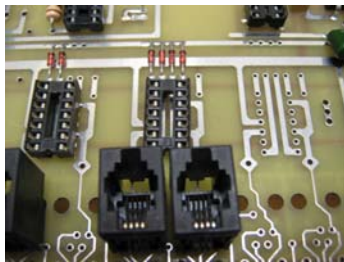

are used as well as four diodes.

Where only one side of the chip is used, take care to install the diodes on the correct side (side with the jack).

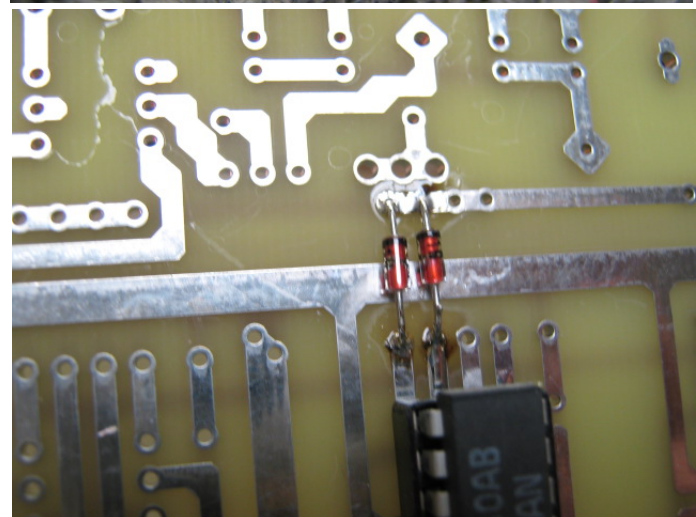
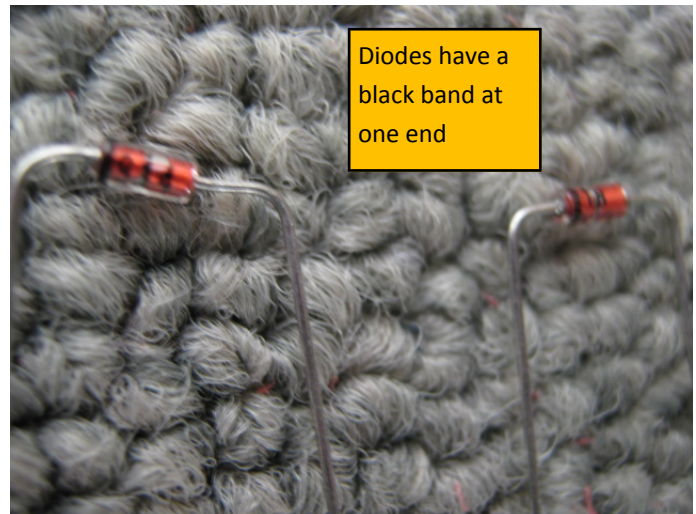
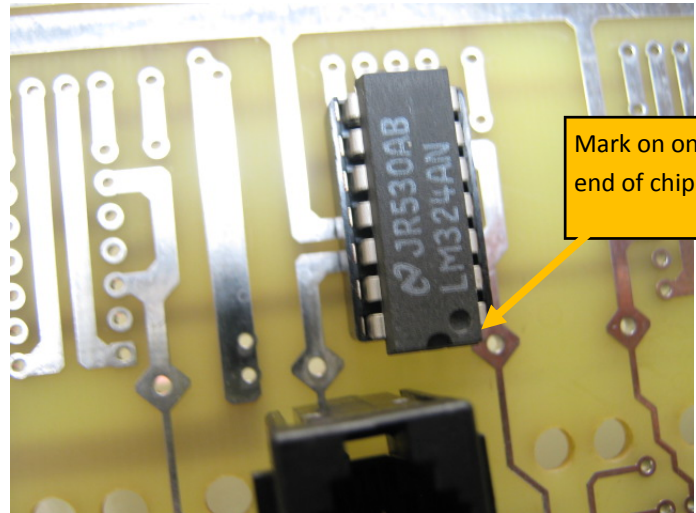
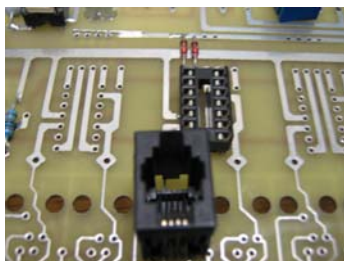

8610C Valco Valve Installation

January 2014

Replace the display board, fiber spacers, lock washers and nuts.

Replace the phone cables which were previously removed and then add a phone cable to the newly installed Valve1 jack.

This phone cable will go to the Heat board.

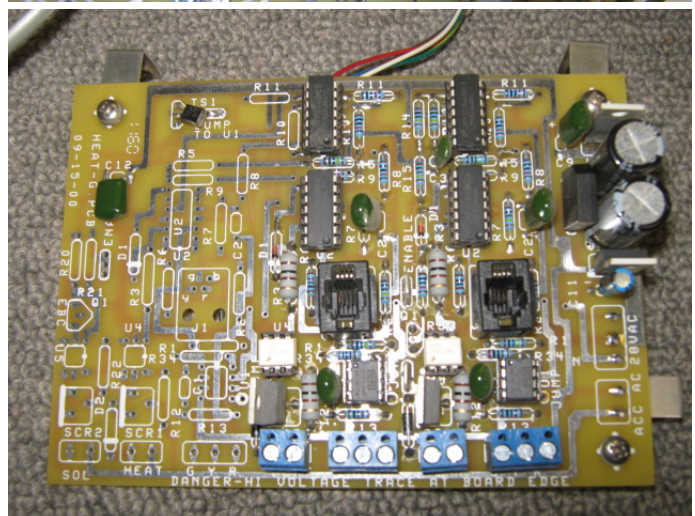
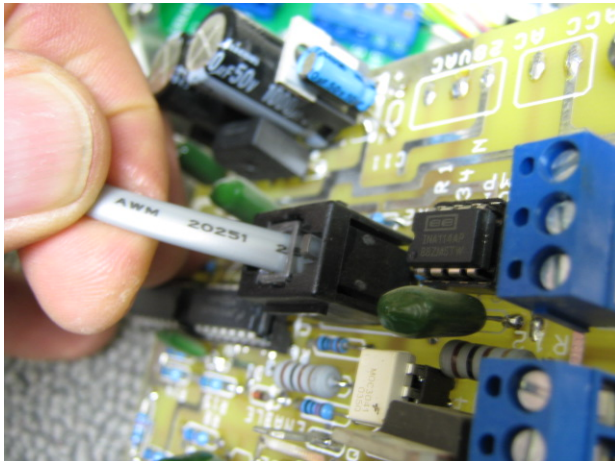
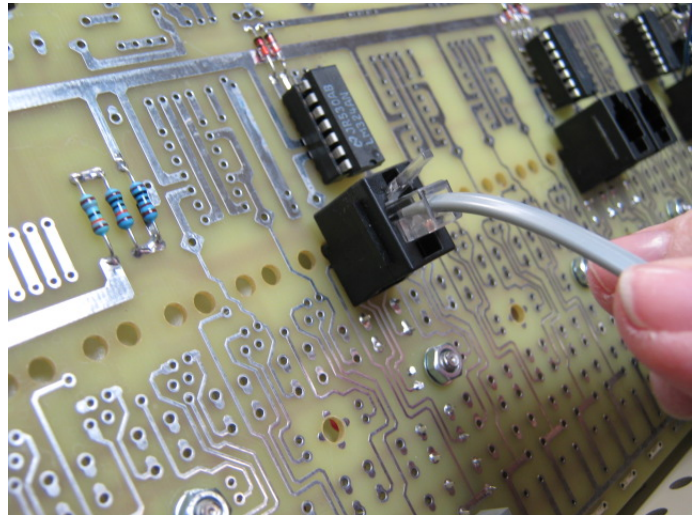

The heat board may have one, two or three identical circuits on it. The heat board shown in the photo has two heat circuits populated on it. The heat board will be mounted elsewhere inside the GC once the valve heater cartridge and thermo-couple are also attached. Back to this part later.

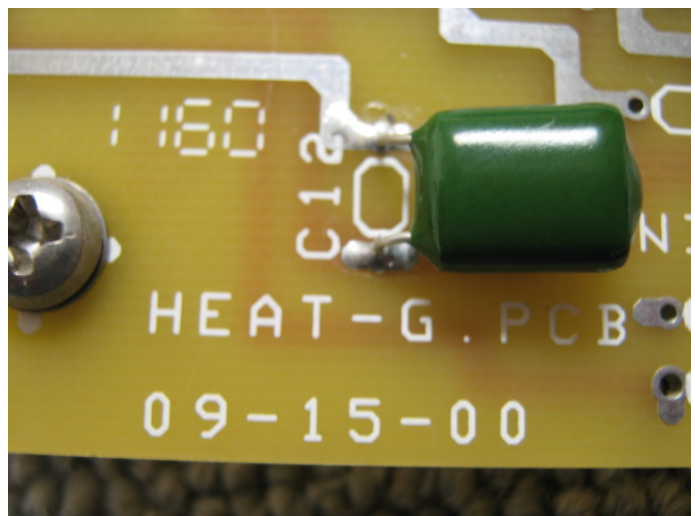

SRI Tech Support: 310-214-5092

8610C Valco Valve Installation

January 2014

Remove the EPCs from the left side of the GC using a 5/64" hex wrench. There are two #6 screws per EPC.

Don't make any electrical disconnections. Just let the EPCs dangle temporarily to give yourself more working room. It's a good idea to mark the EPCs with a magic marker to prevent any confusion when putting them back in.

Be careful of the pressure sensor mounted atop each EPC. The sensor is somewhat fragile.

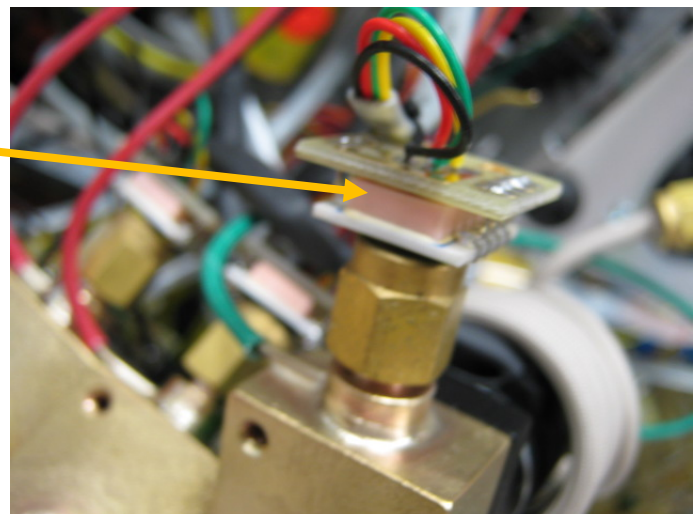
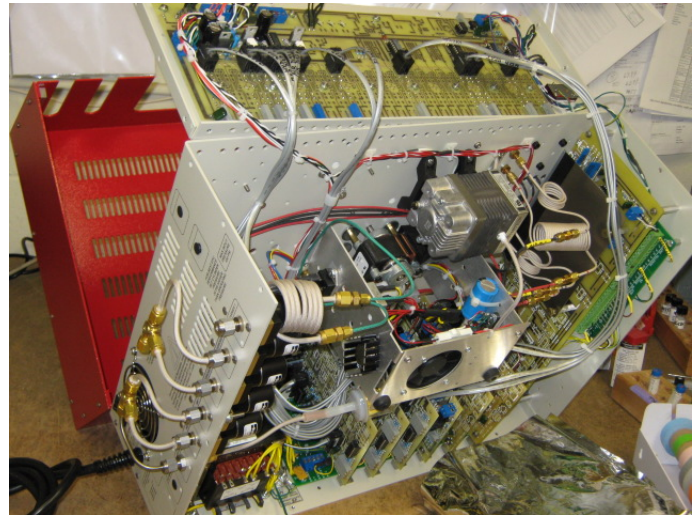

SRI Tech Support: 310-214-5092

8610C Valco Valve Installation

January 2014

If a valve oven had not previously been mounted, the left side of the column oven will have an aluminum cover.

The cover is held in place with two #6 phillips head screws from underneath.

Remove the two screws and the cover will fall off leaving a layer of white insulation.

The insulation is spun glass fluff and is not toxic.

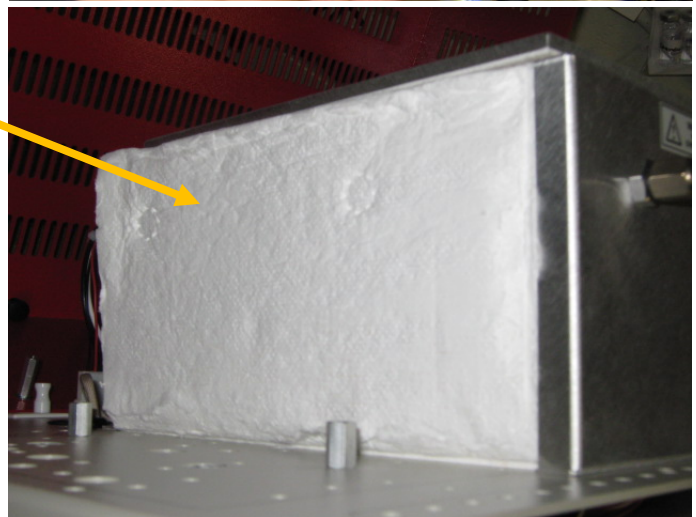
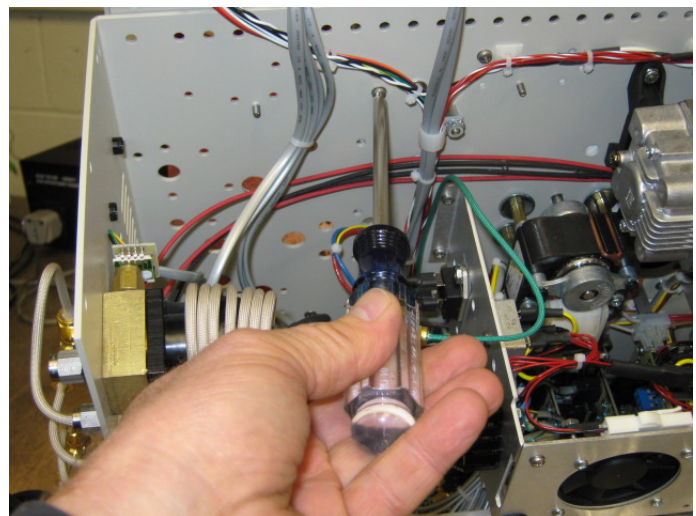
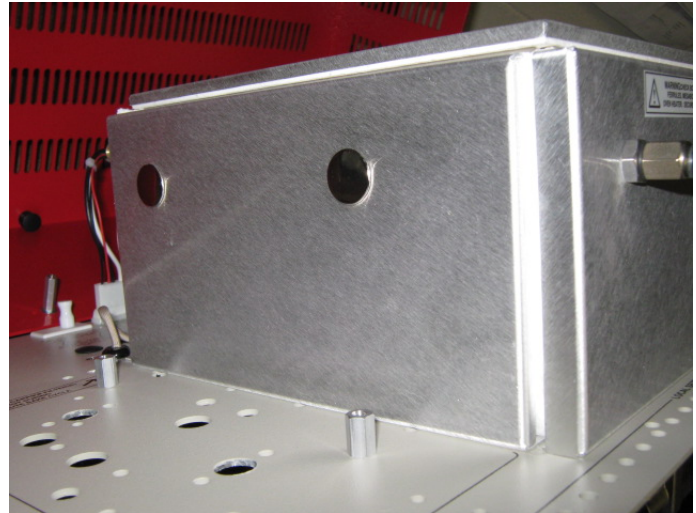

8610C Valco Valve Installation

January 2014

Remove all the black plastic hole plugs in the top surface of the chassis.

Use a screwdriver to punch the plugs out from below.

Verify that you have the correct hardware to mount the valve actuator.

Two #8 standoffs with protruding thread. One with #8 nut, lockwasher and flatwasher.

Two #8 standoffs with bevel head screws.

Three #8 cap head screws

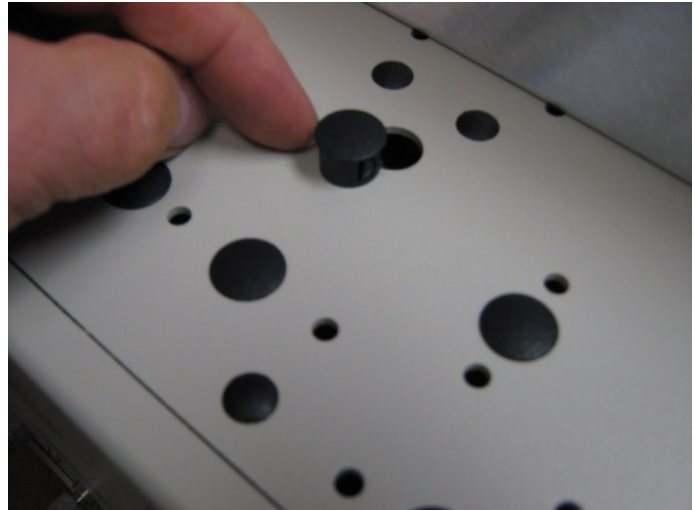

SRI Tech Support: 310-214-5092

8610C Valco Valve Installation

January 2014

The Valco valve and actuator look like the photo at right.

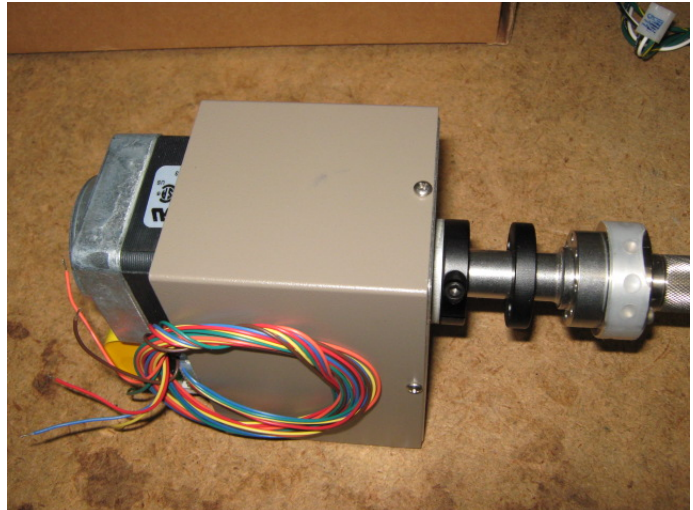

Use a 9/64" hex wrench to remove the valve head from the actuator.

Loosen (don't remove) the nut which clamps the black collet to the shaft of the valve. The valve head will fall away. Don't worry about alignment of the shaft at this point.

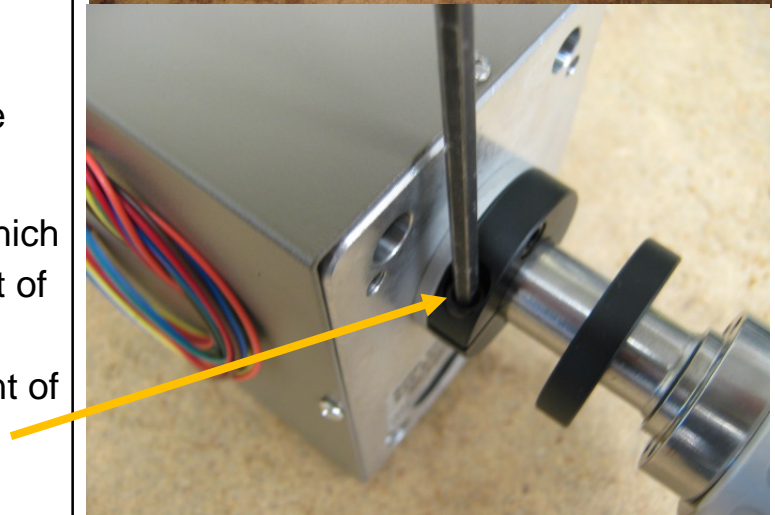

Remove the two additional hex head screws which hold the black collet and a thinner aluminum spacer to the actuator. We won't need the aluminum spacer, but we will need the collet and screws.



SRI Tech Support: 310-214-5092

8610C Valco Valve Installation

January 2014

Install one standoff to support the valve oven. This particular standoff is directly between the actuator and the chassis where it will not be accessible once the actuator is installed.

Inside the chassis you will see a hole which is clearly beveled to accept the bevel head screw.

Tighten this standoff and screw tightly.

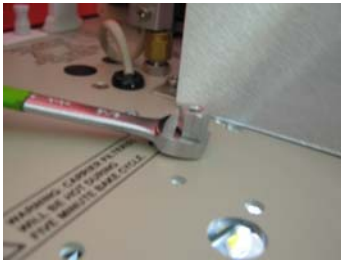

Wiggle the actuator into position, bending any conflicting wires or tubes out of the way. Do not pinch any wires or tubes between the actuator and the chassis.

There are actually two possible valve locations. This installation assumes we will use the location closest to the rear of the GC, which is in the middle of the valve oven. A second Valco valve can be installed in the front-most position if desired. Note the orientation of the actuator in the chassis.

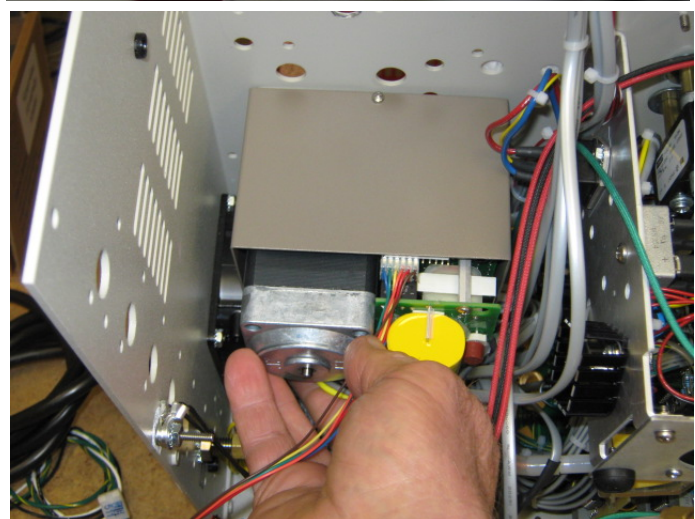
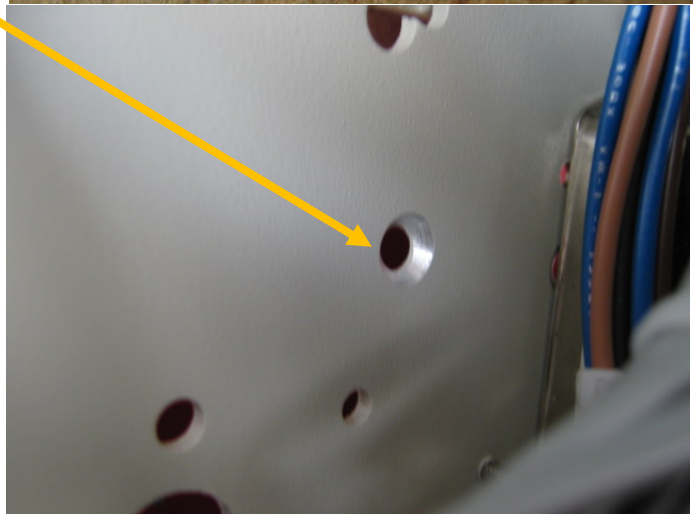

SRI Tech Support: 310-214-5092

8610C Valco Valve Installation

January 2014

Use the standoff with protruding thread to secure the actuator so you don't have to hold it.

Install the three #8 black hex head screws at the other three corners of the actuator. Note that two of the screws are quite close to the white insulation.

Re-attach the black collet so that the collet tightening screw is facing the left side of the GC. This is important because once the valve oven is in place the only access to this screw will be from the left.

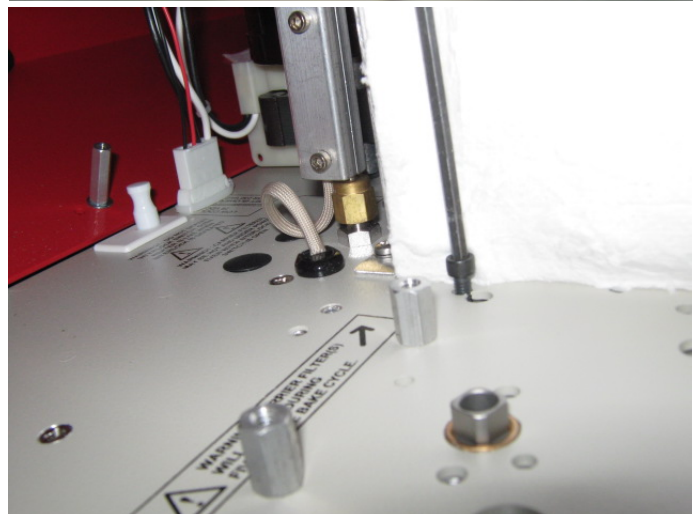
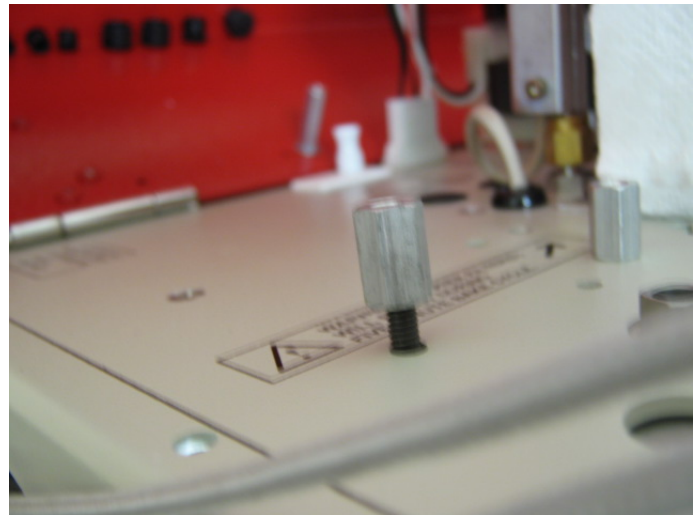

#8 standoff with bevel head screw below

#8 standoff with protruding screw threaded into actuator body

Three black hex head screws

Collet and two hex head screws

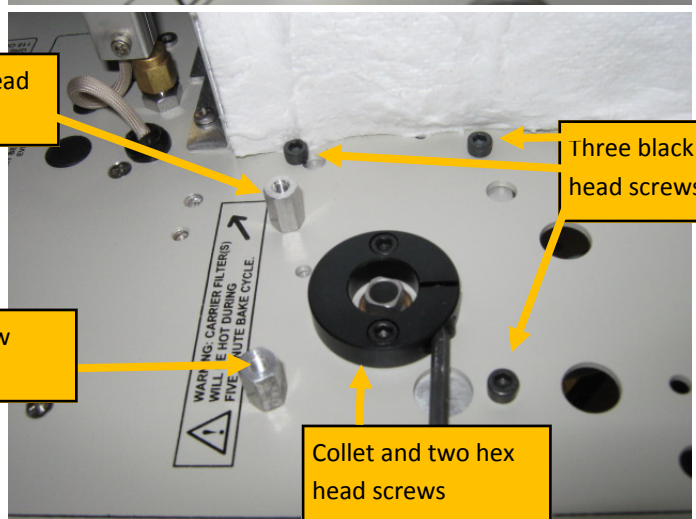

SRI Tech Support: 310-214-5092

8610C Valco Valve Installation

January 2014

Install the #8 standoff with the nut, lockwasher and flatwasher and also the #8 standoff and bevel head screw to support the frontmost two legs of the valve oven.

The photo at right shows the four #8 standoffs mounted and ready to attach the valve oven.

Verify you have the required screws shown below.

12 #6 x 1/4" hex head screws

1 #6 x 1/2" hex head screw

4 #8 x 1/4" phillips head screws

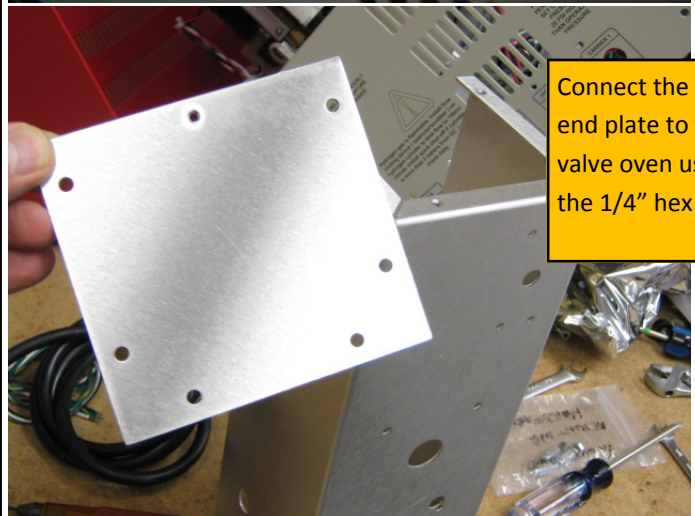
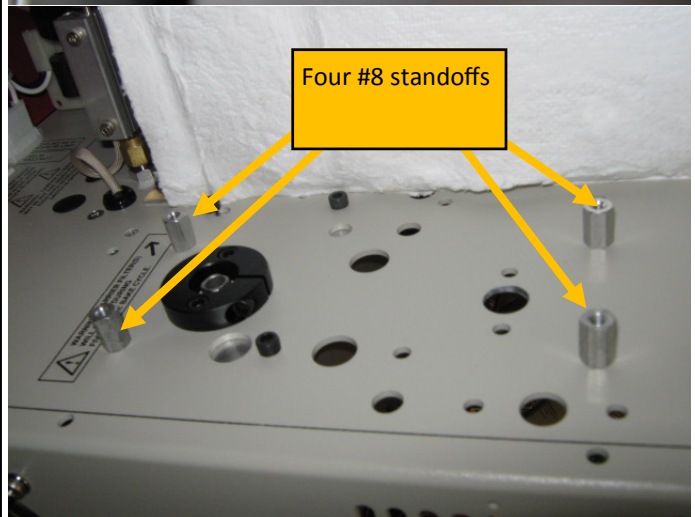

SRI Tech Support: 310-214-5092

8610C Valco Valve Installation

January 2014

Drive the #6 x 1/2" hex head screw into the PEM nut at the top center of the read cover plate. This provides a hook for securing the lid of the valve oven.

Slide the valve oven into position up against the white oven insulation and secure it with the 4 #8 x 1/4" phillips head screws.

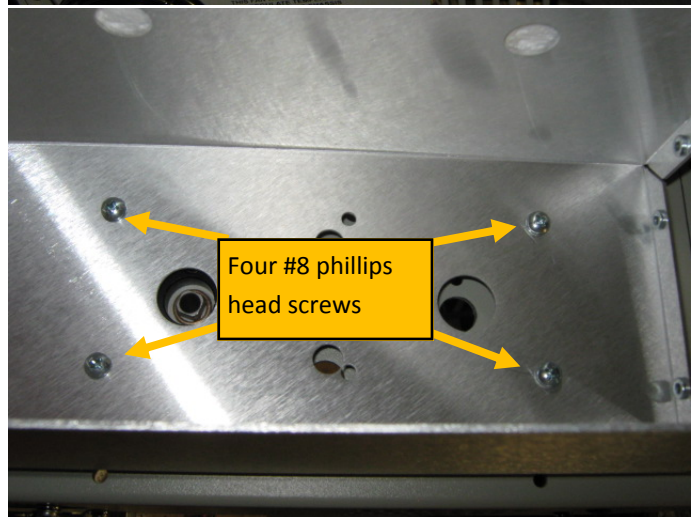
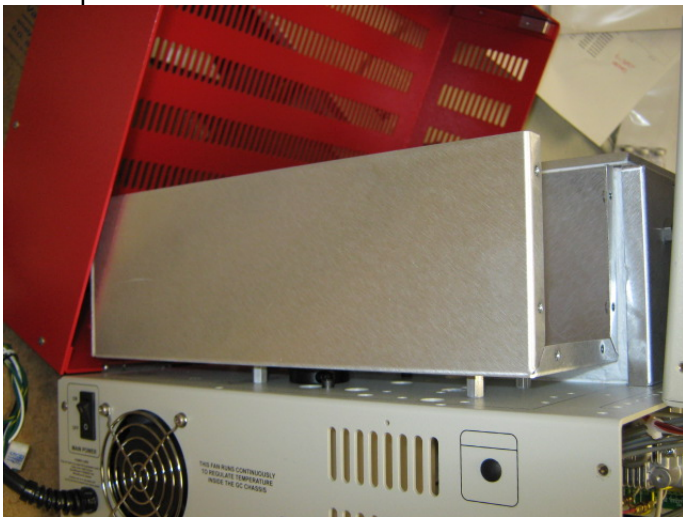
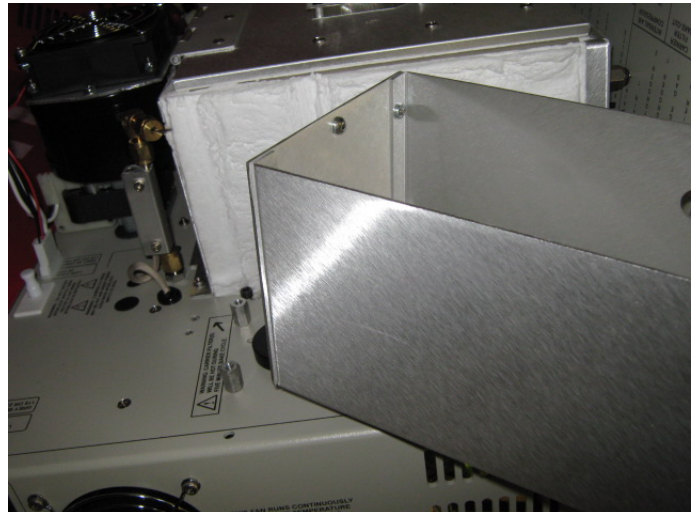

SRI Tech Support: 310-214-5092

8610C Valco Valve Installation

January 2014

Drive the #6 x 1/2" hex head screw into the PEM nut at the top center of the rear cover plate. This provides a hook for securing the lid of the valve oven.

Slide the valve oven into position up against the white oven insulation and secure it with the 4 #8 x 1/4" phillips head screws.

The white insulation inside the valve oven has been removed for clarity.

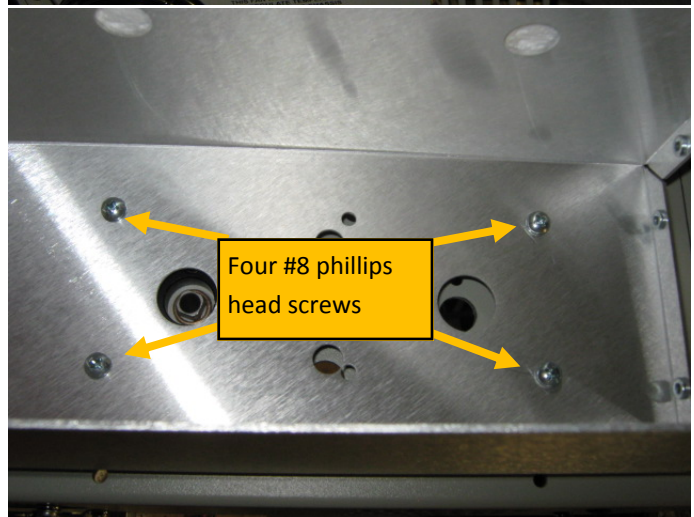
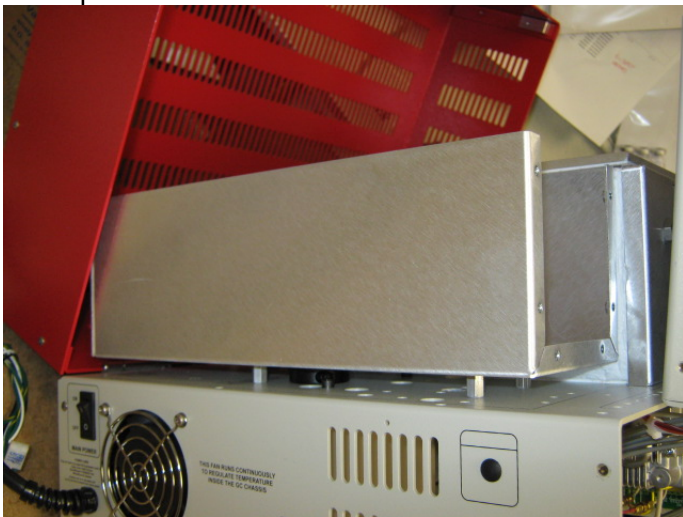
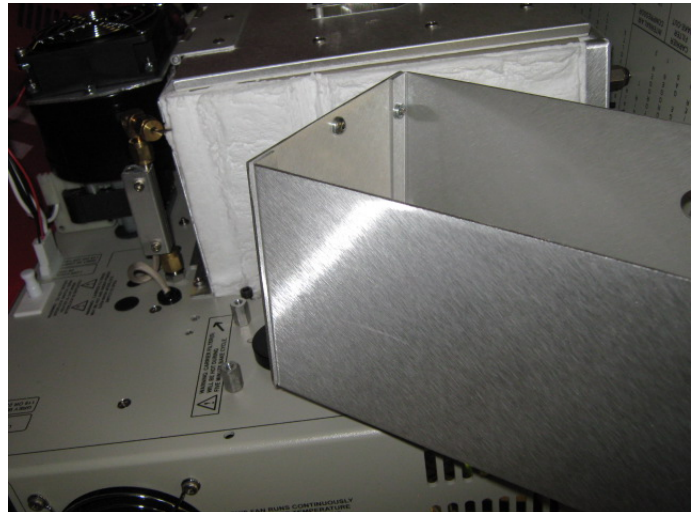

8610C Valco Valve Installation

January 2014

It is likely that the valve oven is already insulated however.

If not, then lay a piece of the white insulation in the bottom of the valve oven and use a screwdriver to poke a hole where the valve shaft will go through.

Connect the cartridge heater (100 watt) to the heater block using a 1/16" hex wrench to secure the cartridge heater in place.

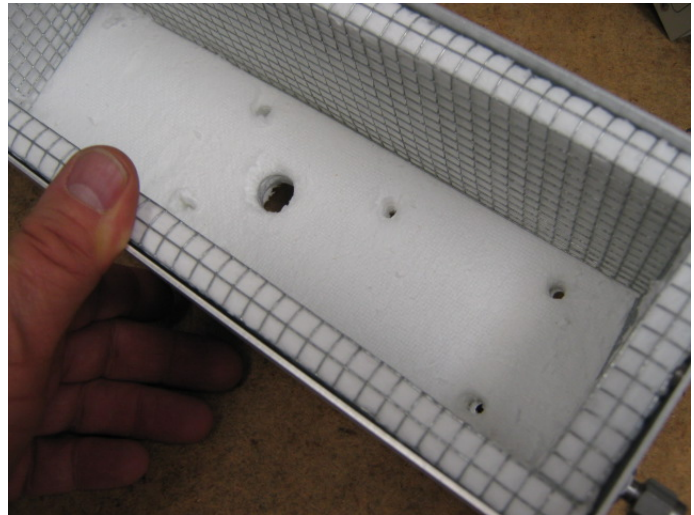

Cartridge heater and thermo-couple wires are bundled together.

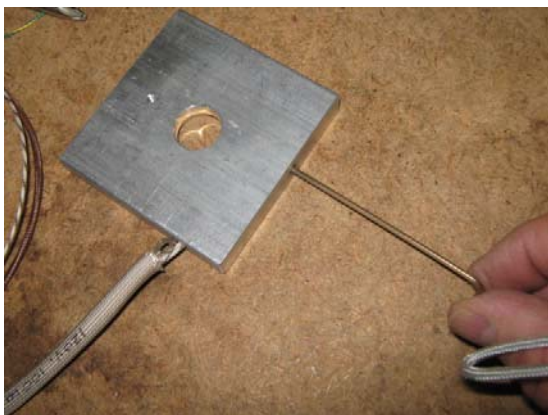

8610C Valco Valve Installation

January 2014

Use a 7/64" hex wrench to remove the extra black collet which comes with the Valco Gas Sampling Valve (GSV)

With the #1 port of the GSV facing towards the front of the GC insert the valve shaft through the heater block and engage the drive shaft of the actuator below. The valve should sit directly on the heater block as shown in the photo.

Using the 7/64" hex wrench, secure the thermocouple's ring terminal to one of the hex screws on the valve.

The thermocouple is how the GC will control the valve temperature.

You may also secure that valve head to the actuator by using a 9/64" hex wrench to tighten the collet. Or you can wait to do this until after the valve had had the tubing attached to it.

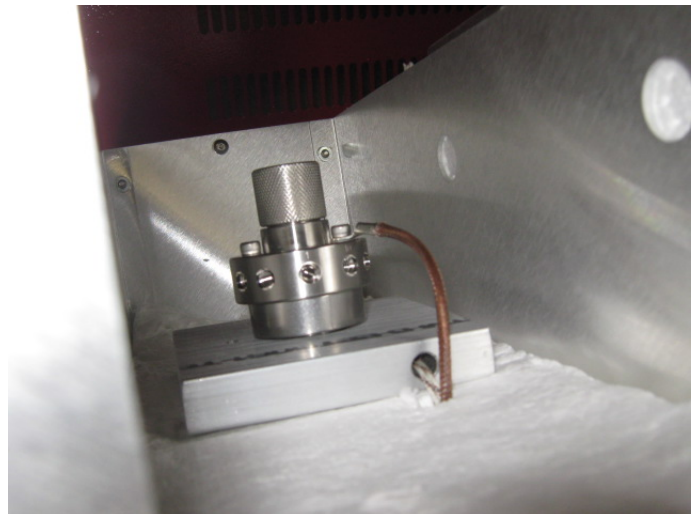

SRI Tech Support: 310-214-5092

8610C Valco Valve Installation

January 2014

Feed the heater and thermocouple wires down through the insulation in the valve oven and then down through the hole in the valve oven and chassis so the wires emerge at the location shown in the photo.

Route the wires through the GC in some neat manner to somewhere near the heat board. You will see other thermocouple and heat wires bundled together.

Cut the wires to some convenient length which also allows some slack so you can work on the heat board as shown.

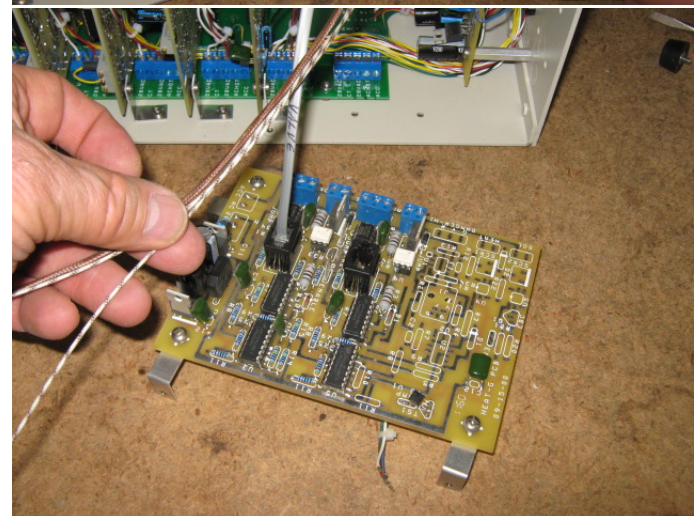
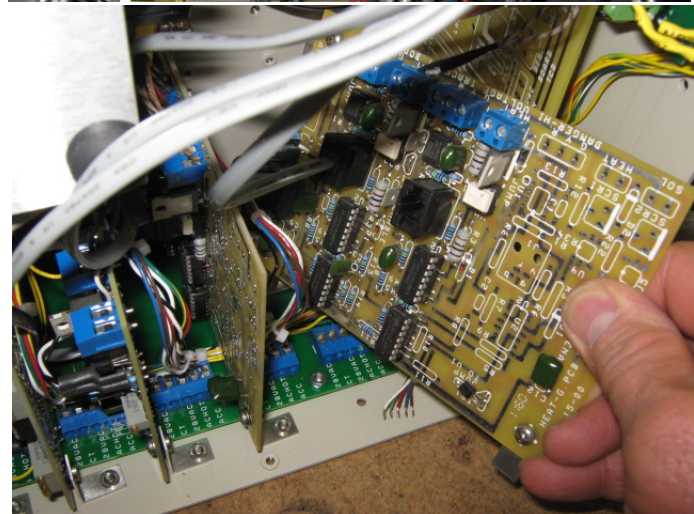
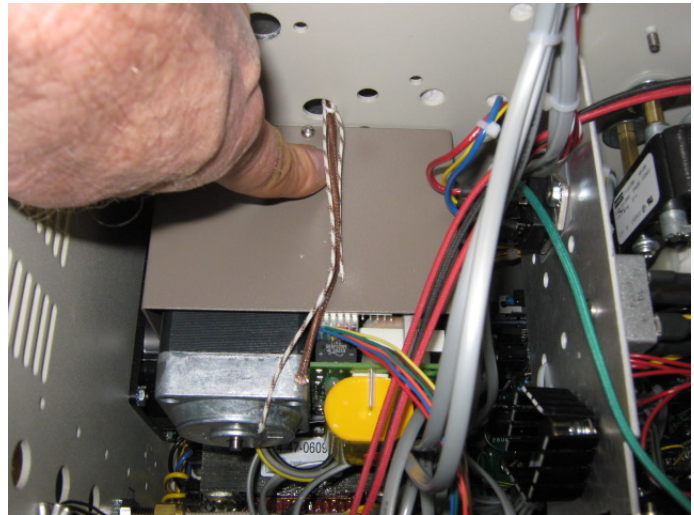

SRI Tech Support: 310-214-5092

8610C Valco Valve Installation

January 2014

Because they have to survive high heat, the heater and thermocouple wires are made of a cloth fiber rather than plastic. It is difficult to strip the insulation from this kind of wire because it tends to fray rather than cut cleanly. Slide a bit of heat shrink tubing over the wires before stripping the insulation to keep the insulation from fraying even further.

The thermocouple wire has an outer layer of brown insulation. Strip about 2 inches (5 cm) of the outer insulation away to expose the red, yellow and white wires inside.

Slip the heat shrink on before stripping the insulation off the inner wires. Use a heat gun to set the heat shrink tubing.

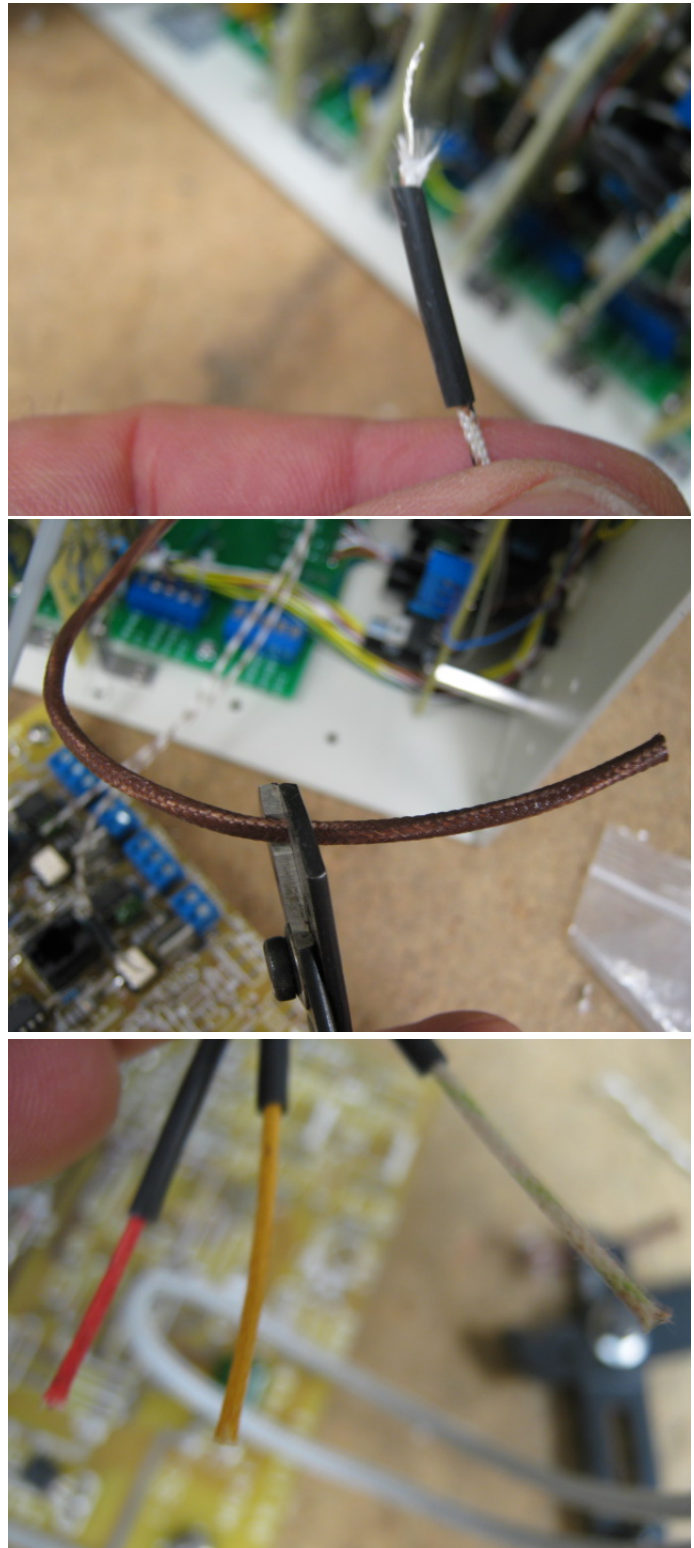

SRI Tech Support: 310-214-5092

8610C Valco Valve Installation

January 2014

The heat board may have one, two or three identical circuits. Each heat circuit has a 3-screw terminal for the thermocouple connection, and a 2-screw terminal for the heater wires.

Use any of the available circuits as they are all identical. The heat board shown in the photo has two circuits populated on the board.

Secure the thermocouple and heater-wires as shown.

The heat board also has five wires which connect to the AC power distribution board (runs across the inside back of GC). Connect to the closest free set of 5 screw terminals as shown.

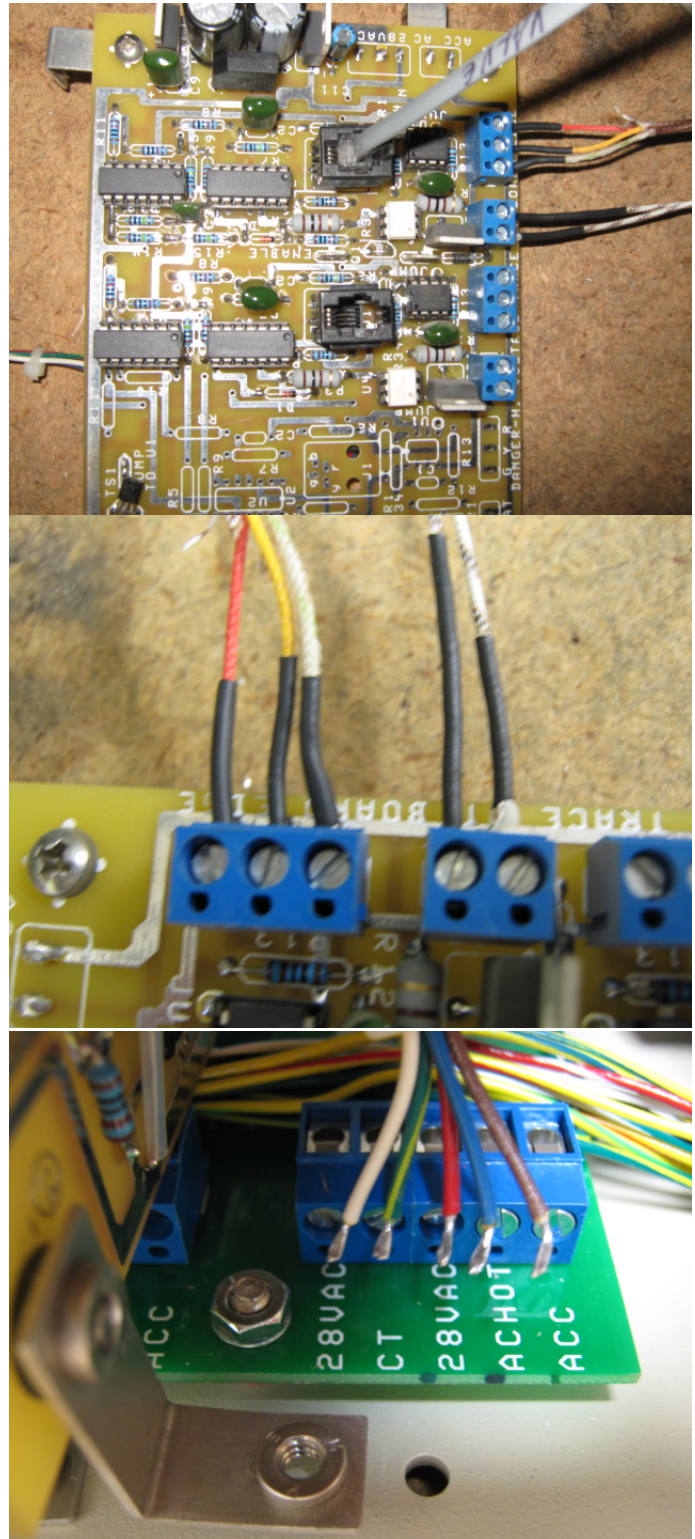

8610C Valco Valve Installation

January 2014

Replace the EPCs which may have been temporarily relocated to provide more working room.



The EPCs and the valve actuator are close to each other, so take care when re-installing the EPCs not to damage the pressure sensor. Depending on exactly how many EPCs are installed, the 5th EPC (from the front) may need to have the pressure sensor mounted on a short section of tubing to clear the actuator.



Locate the actuator control cable which should already be plugged into the actuator. Only the orange, red and brown wires are used, so the others may be cut or tied off.

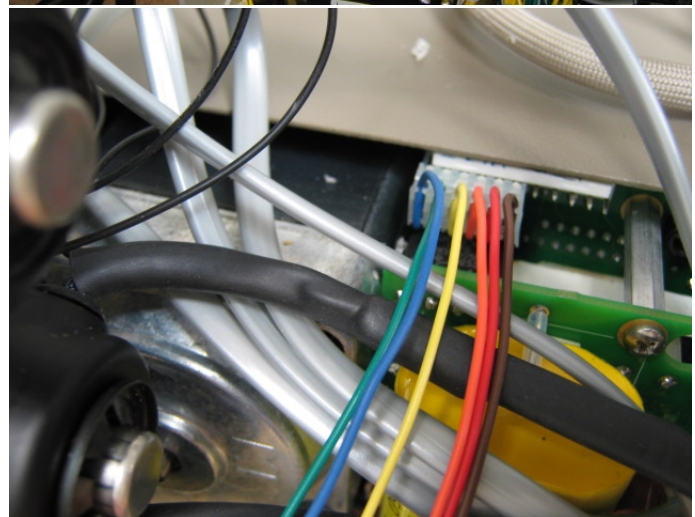

SRI Tech Support: 310-214-5092

8610C Valco Valve Installation

January 2014

Locate the Relay board. This circuit board has 1,2,3 or 4 single pole dual throw mechanical relays mounted.

The board shown at right has 4 identical relay circuits. Each circuit has 3 screw terminals which correspond to the Normally Open (NO), Common (C), and Normally Closed (NC) connections of each relay.

The Relay board mounts in the inside right rear of the chassis, where it is half hidden by the amplifier board.

Secure the Relay board with 4 #6 x 1/4" hex head screws driven in from the right side.

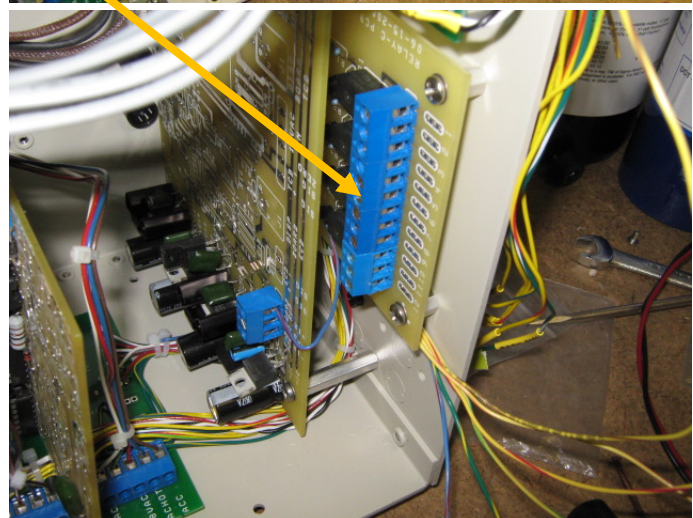
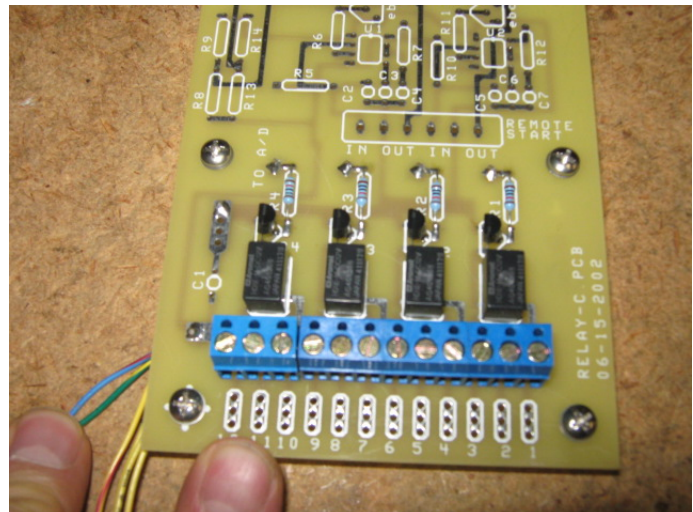

SRI Tech Support: 310-214-5092

8610C Valco Valve Installation

January 2014

The Relay board's green/yellow ground wire connects to the chassis ground stud. You will see many other green/yellow wires connected here.

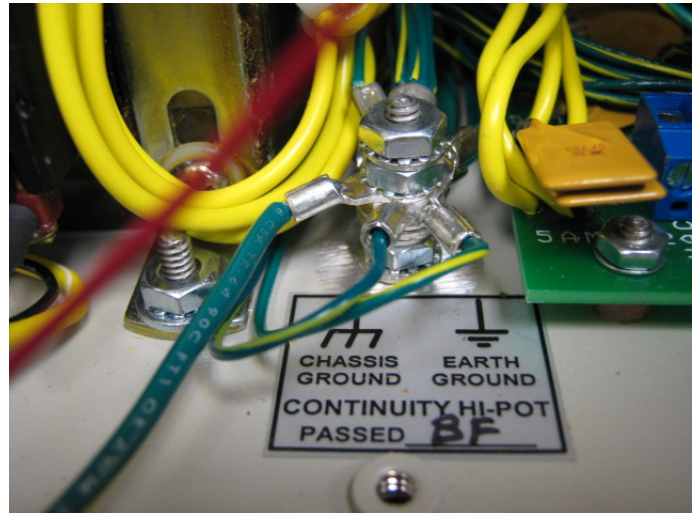

The Relay board's blue/red +12voltDC power wire connects to the screw terminal on the amplifier board. You will see at least one other blue/red wire already connected here.

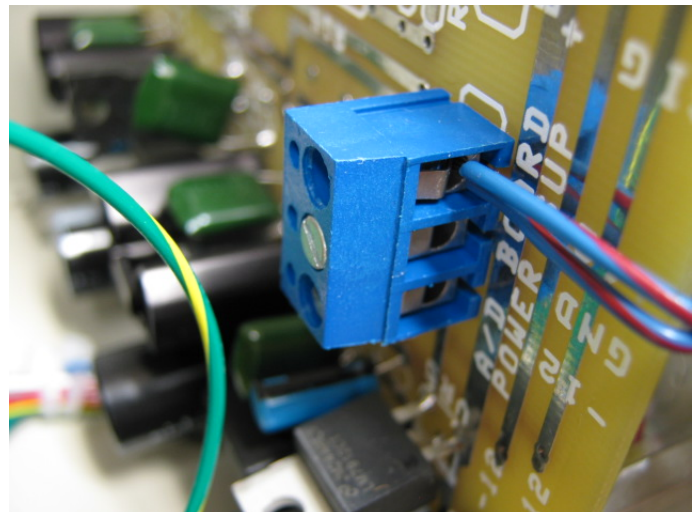

The screw terminal on the amplifier board is sometimes hard to reach without a short screwdriver.

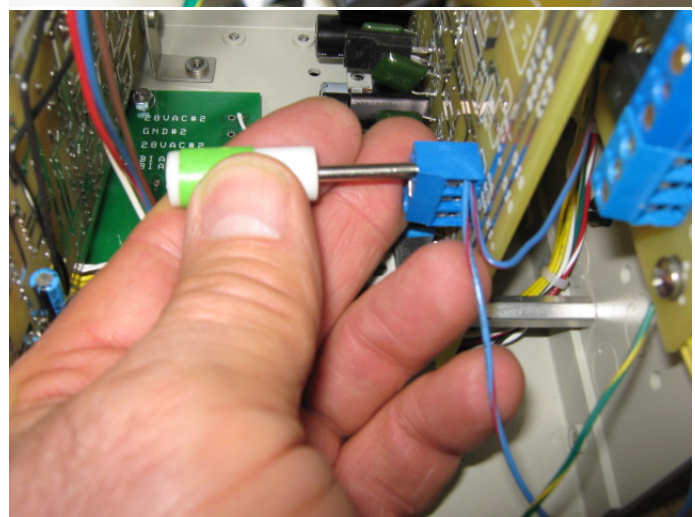

SRI Tech Support: 310-214-5092

8610C Valco Valve Installation

January 2014

Connect the relay control wire to the A/D board's digital output. In the photo at right, the yellow/brown control wire is connected to the A/D board's "G" output. Depending on how many of the A-H outputs are already in use, you may have to select another one.

If you select output "G", then the valve will be controlled by Relay G in the PeakSimple software.

You may also have to select a different relay if the yellow/brown relay is not populated or is already in use.

Relay control wire connected to A/D board's "G" output

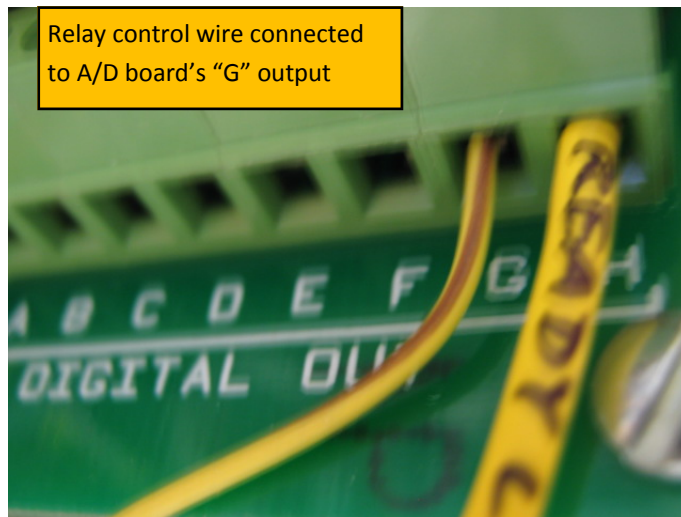

Yellow/green yellow/orange yellow/red yellow/brown

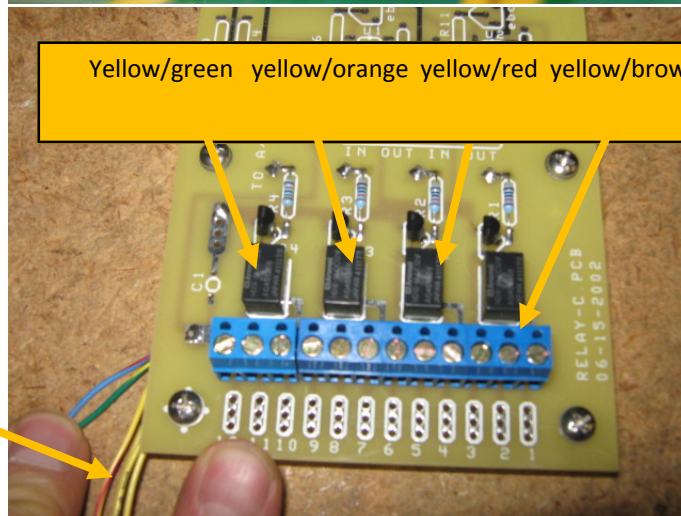

Relay control wires

A/D board

Amplifier board

Relay board

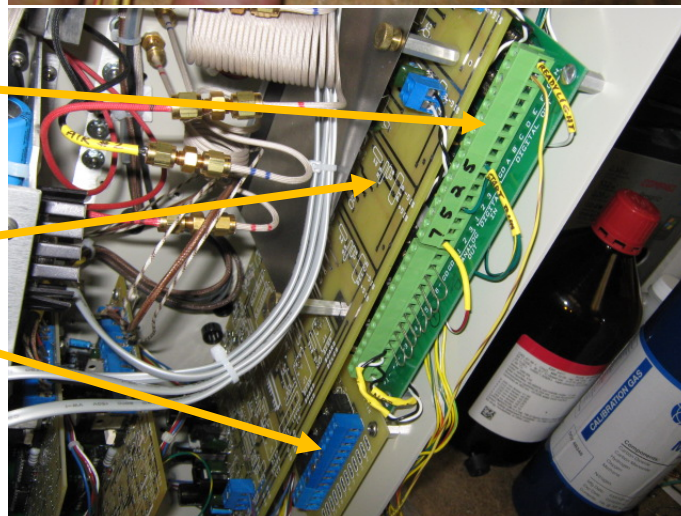

SRI Tech Support: 310-214-5092

8610C Valco Valve Installation

January 2014

Run the 3 colored wires from the Valco actuator (red, brown and orange) over to the Relay board.

It is best to use a varglas sleeve to protect the wires, but not absolutely necessary.

Connect the wires as shown. From left to right, the colors are orange, brown red.

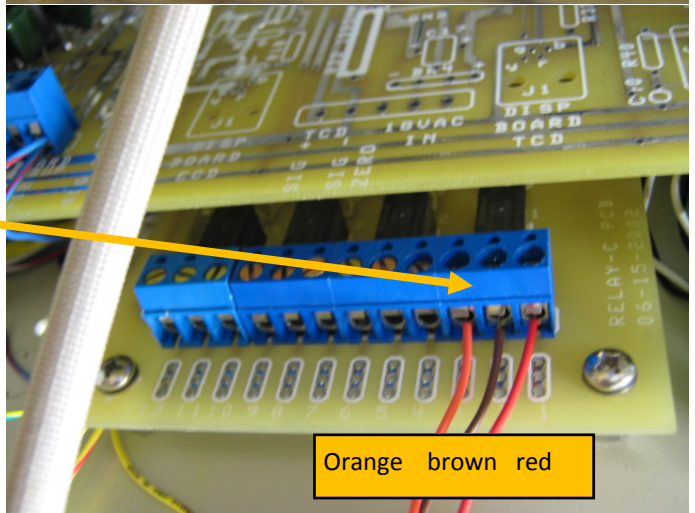
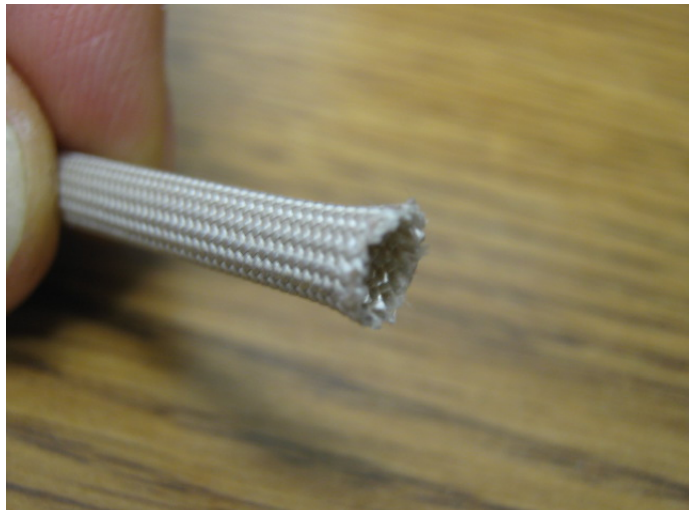
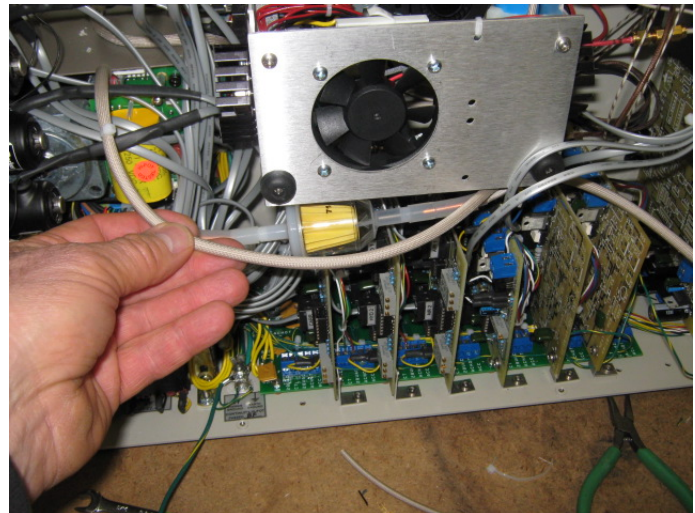

Orange brown red



SRI Tech Support: 310-214-5092

8610C Valco Valve Installation

January 2014

Find the power cable for the actuator which looks like the photo. The cable contains three wires:

Green/yellow chassis ground

Black AC hot

White AC neutral

The cable pushes onto a connector at the bottom of the actuator.

Connect the green/yellow wire to the chassis ground stud after cutting it to a convenient length and crimping on a #6 ring terminal.

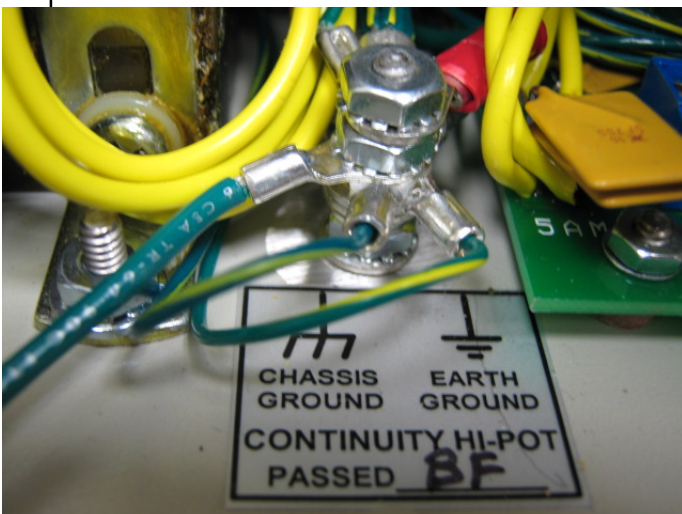
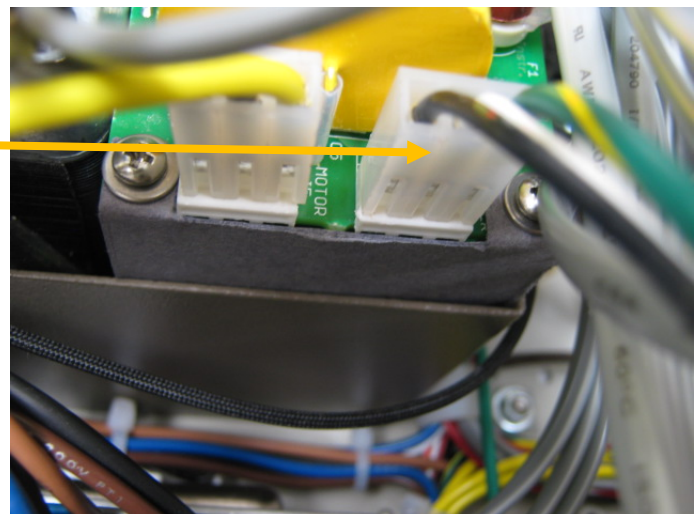
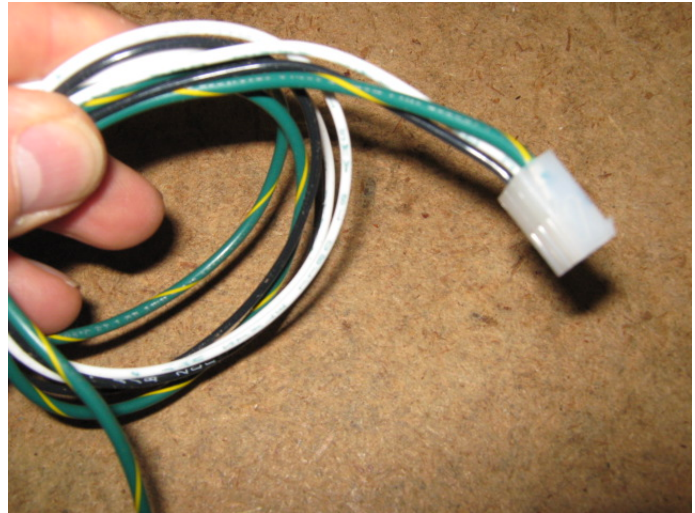

SRI Tech Support: 310-214-5092

8610C Valco Valve Installation

January 2014

The back and white wires connect to a Wago power distribution block (Wago) which is located just behind the main power transformer.

The Wago block is segmented into different zones. The black wire connects to the orange zone (AC hot).

The white wire connects to the green zone (AC neutral).

The Wago block has a little jaw which bites down on the stripped wire. To open the jaw so you can insert the wire, you pry the jaws open with a small screwdriver. So you insert the screwdriver, and pry to one side to open the jaw. Insert the wire and then release the screwdriver. Pull on the wire. You should not be able to pull the wire out.

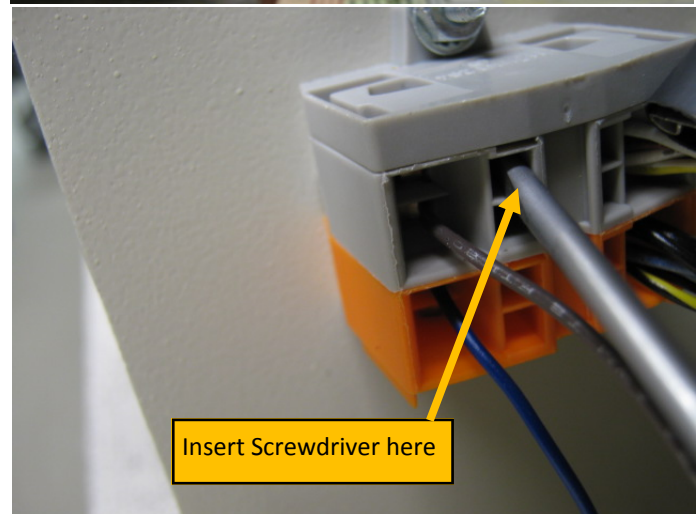
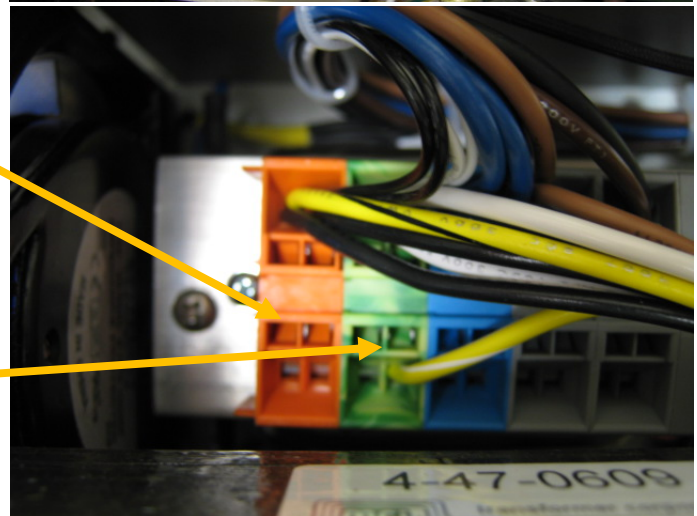
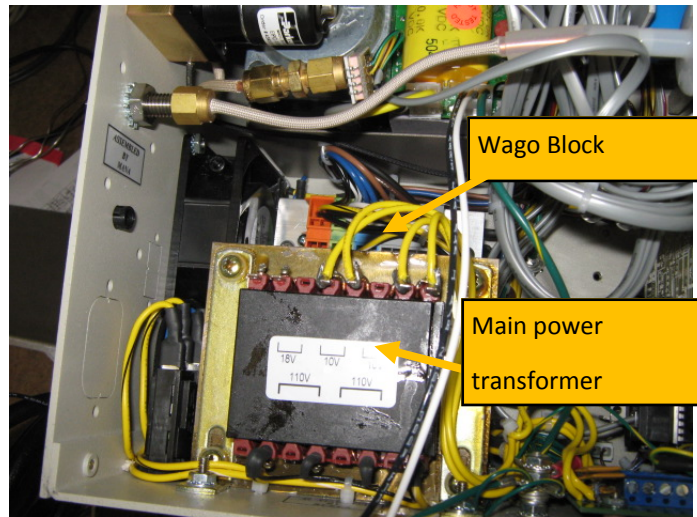

SRI Tech Support: 310-214-5092

8610C Valco Valve Installation

January 2014

Cut the black and white wires to a convenient length and strip the insulation.

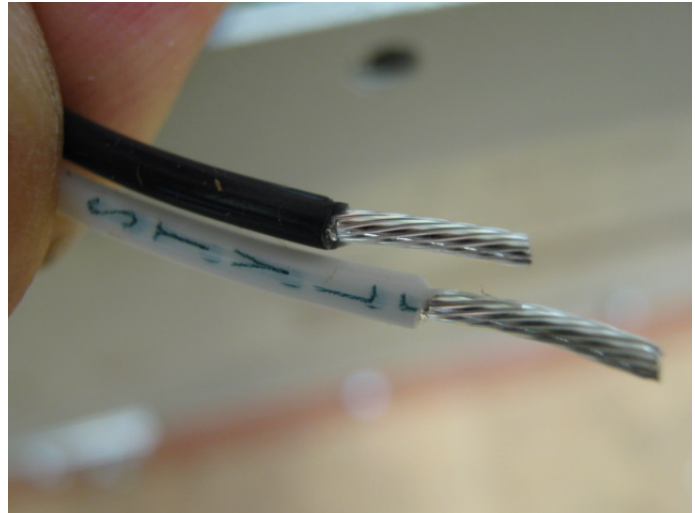

Insert the black and white wires in the Wago block as shown. Black to orange, and white to green.

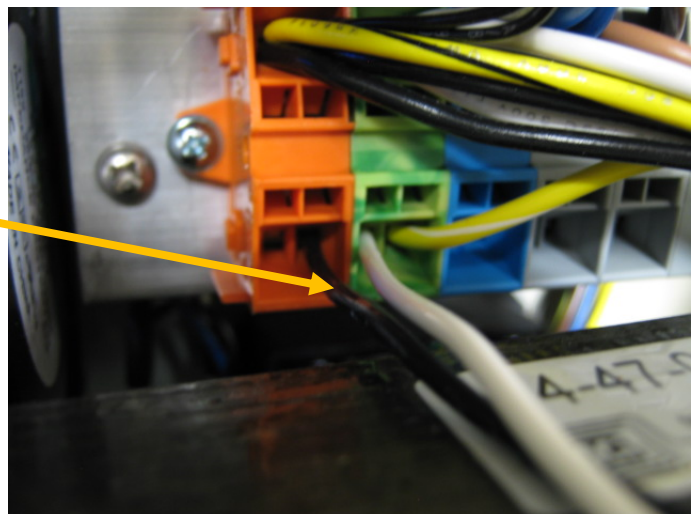

Re-assemble the GC, since all the modifications inside the GC are now complete.

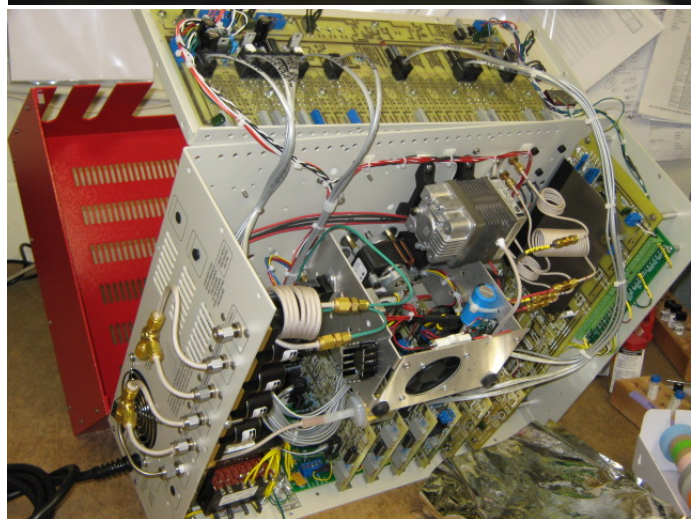

SRI Tech Support: 310-214-5092

8610C Valco Valve Installation

January 2014

Shown at right are wire cutting pliers which can also be used to cut the 1/16" stainless steel tubing used to plumb the Valco valve.

The yellow handled version is supplied with SRI GCs. The red handle version is a more expensive type available from many sources (Restek, Grace, Supelco etc).

You hold the cutter perfectly straight and perpendicular to the tubing. Then cut in one swift motion. You may have to practice until you can get a clean cut which does not deform the tubing or close off the hole.

A good cut looks like this. If you can't cut the tubing as good as this, then you may need a new cutter or a better tool. Don't file the ends of the tubing, as metal dust can damage the valve over time.

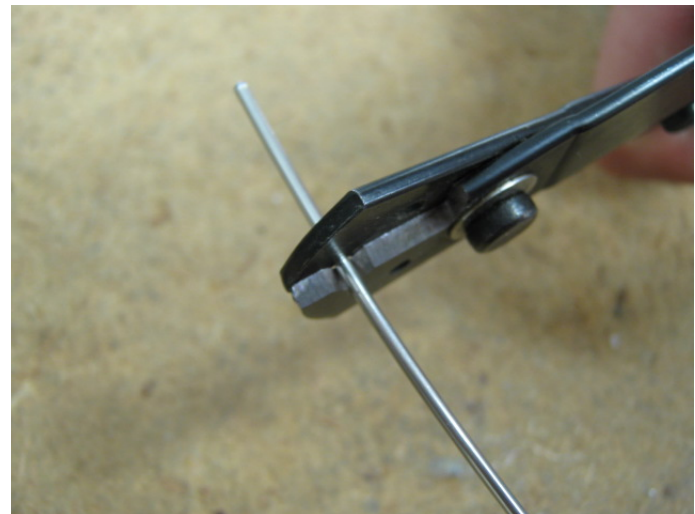

SRI Tech Support: 310-214-5092

8610C Valco Valve Installation

January 2014

The Valco valve has 10 ports which are labelled with the numbers 1-10 stamped into the metal.

The valve can be plumbed many different ways depending on the goals of the analysis.

You should have sufficient Valco nuts and ferrules to connect a tube to every one of the 10 ports. We use brass ferrules (because they seal better and come out easier), but you can also use the stainless steel version

Do not use Swagelok or other brand nuts and ferrules. Use only the correct Valco nuts and ferrules to connect the tubing.

This is what the tubing looks like after the Valco nut and ferrule have been tightened and then removed.

It is good practice to inspect each connection after it is made to insure that it looks like the photo at right.



8610C Valco Valve Installation

January 2014

Connect your tubing to the valve.

Example Valco diagrams are available at the Valco website:

www.vici.com

The valve head should be oriented so that port 1 is closest to the front of the GC.

Tighten the collet which holds the valve head to the actuator using a 9/64" hex wrench.

Verify that the actuator operates when Relay G is clicked in the PeakSimple software.

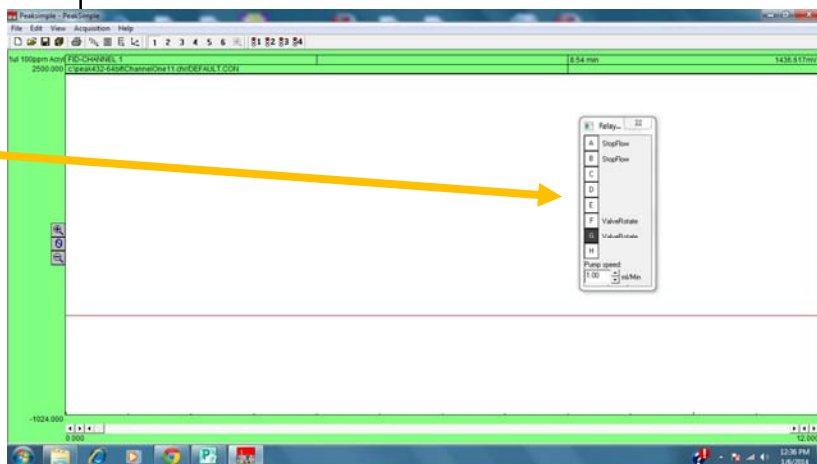
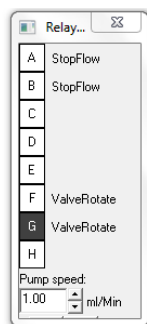

SRI Tech Support: 310-214-5092