

# Multiple Gas#5 GC configuration

## Jan 2016

### History:

Unfortunately there is no single column that can separate:

Hydrogen  
Oxygen  
Nitrogen  
Methane  
CO  
CO2  
Ethane  
Water  
Propane  
Butane  
Pentane

Over the years SRI Instruments has devised several solutions to this analytical problem, starting with the MultipleGas#1 configuration and evolving to the present MultipleGas#5 configuration.

Like the earlier MG GCs the 8610C chassis includes an ambient to 400C programmable column oven.

Inside the column oven are three columns. There can be additional columns, but the basic MG5 includes:

.5 meter Haysep-D precolumn  
2 meter MoleSieve 5A column  
2 meter Haysep D column

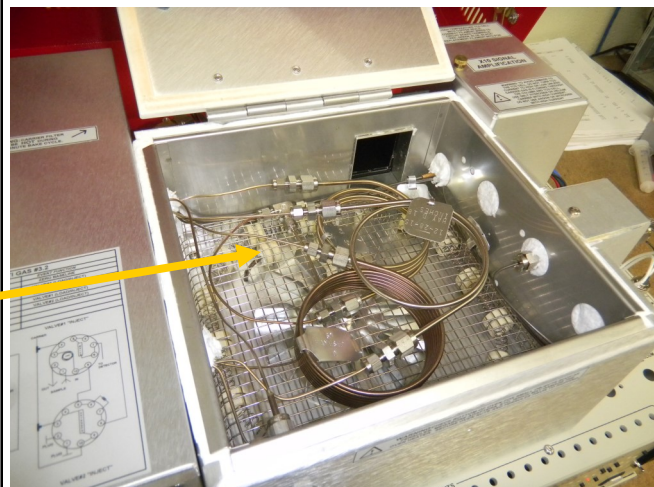
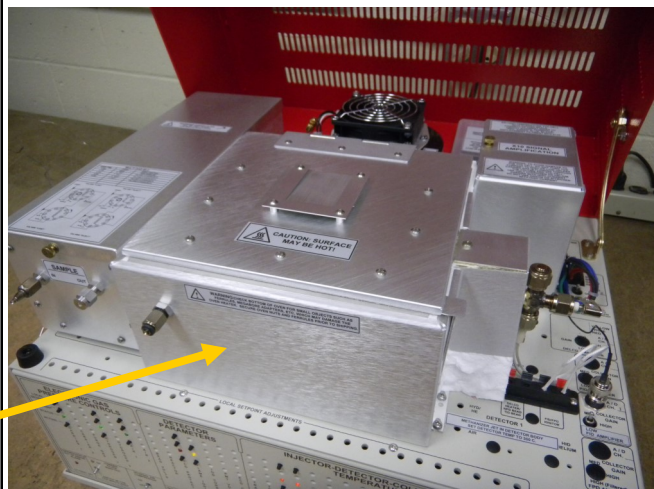
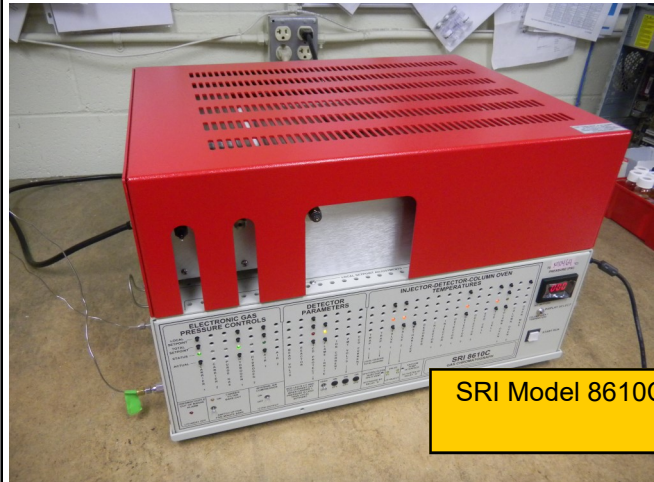

# Multiple Gas#5 GC configuration

## Jan 2016

On the right side of the column oven is located the Thermal Conductivity Detector ( TCD ) which detects all the gases from 200ppm to 100% except hydrogen ( see detailed explanation for this later ).

Most MG5 configurations will also include a Flame Ionization Detector ( FID ) usually also including a Methanizer ( FIDmeth ) to enable the FID to also detect CO and CO<sub>2</sub> from 1ppm to 50,000ppm. The FID can only detect hydrocarbons like methane and ethane, but when equipped with a methanizer, CO and CO<sub>2</sub> are reacted to methane and thus detected at the same sensitivity as methane.

On the left side of the column oven is the valve oven, which contains two 10port Valco valves and lots of 1/16" stainless steel tubing.

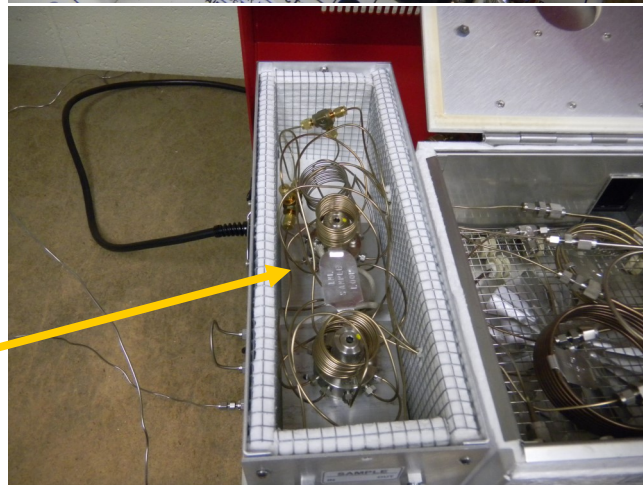
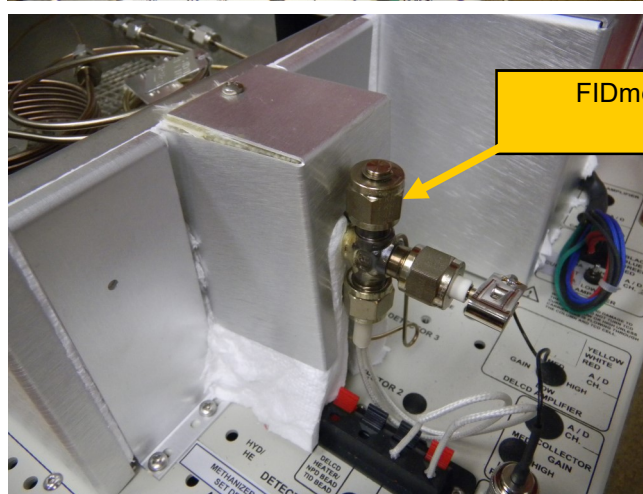
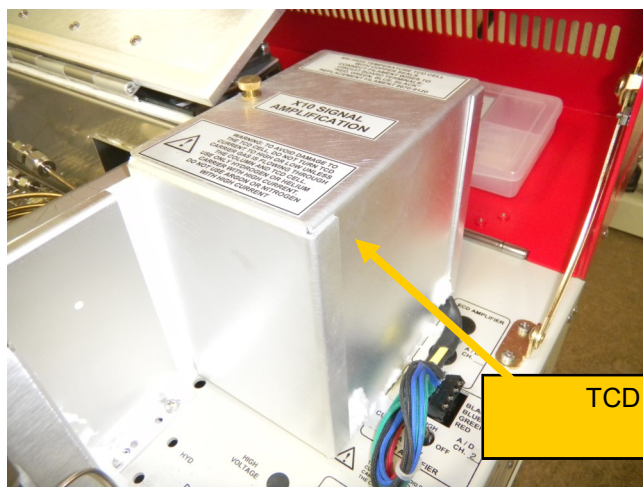

# Multiple Gas#5 GC configuration

## Jan 2016

The Valco 10port gas sampling valve ( GSV ) looks like this. There is an electric motor inside the GC which turns a Teflon seal inside the valve at a specific time during the analysis to change the carrier gas flow path.

We put a map on the cover of the valve oven so you can follow the carrier gas flow path in both positions ( load and inject ). It is important to understand the flow path to troubleshoot and optimize the analysis. It is also critical to understand that the valve does not “open” or “close”. Rather, the carrier flows in one path or the other, but it always flows continuously.

The sample to be analyzed is loaded at the front of the valve oven. The sample can flow from the “sample IN” through the “loop” and then out the “Sample OUT” continuously, or it can be flushed with new sample prior to starting an analysis. Normally it takes a minimum of 10ml of sample to flush the loop. There is no restriction or pressure to work against. You could blow through from “In” to “Out” with your mouth.

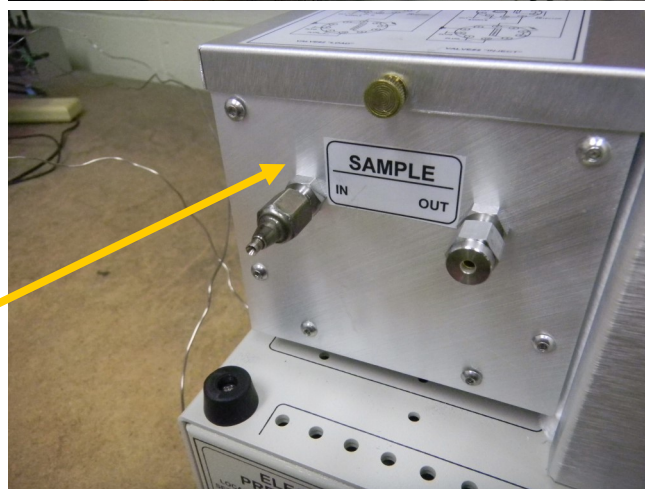
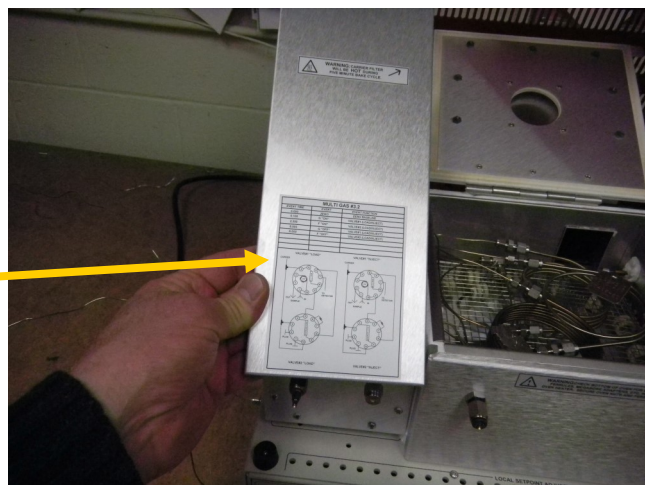

# Multiple Gas#5 GC configuration

## Jan 2016

The carrier gas is connected to the left side of the GC. The carrier gas can be helium, hydrogen, nitrogen or argon. Inside the GC there is a very precise pressure regulator called an “ Electronic Pressure Controller” ( EPC ) which supplies the carrier gas at a stable pressure to the valves and columns.

Helium is the most common choice because it gives the best overall results. However the sensitivity is not as good for hydrogen as it is for the other gases. This is because the TCD sensitivity depends on the difference of the “thermal conductivity” of the carrier gas relative to the sample molecule. The “thermal conductivity” difference between helium and hydrogen is very small

Hydrogen is sometimes used as carrier, but when it is, there is no sensitivity for hydrogen at all.

Nitrogen is sometimes used especially where it is important to measure hydrogen. Naturally, if nitrogen is used as carrier gas, there is no sensitivity to measure nitrogen.

Argon is used where it is important to measure hydrogen and also oxygen and nitrogen.

If an FIDmethanizer detector is also installed, then hydrogen is also connected on the left side of the GC. Air is typically supplied from the built-in air compressor, but can also be supplied from an external air cylinder. Both hydrogen and air are required for the FID flame.

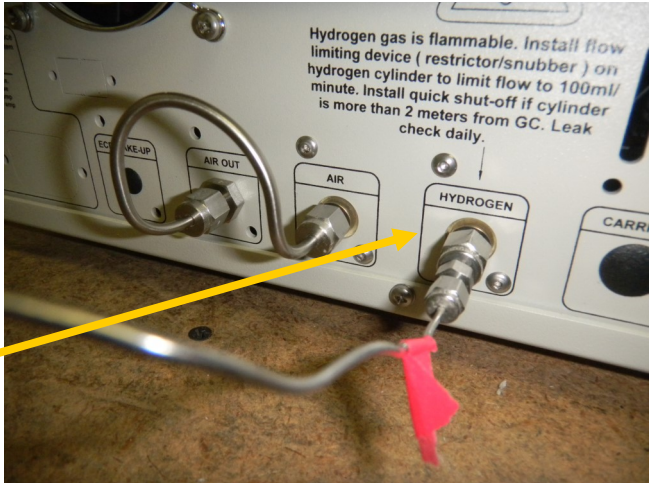
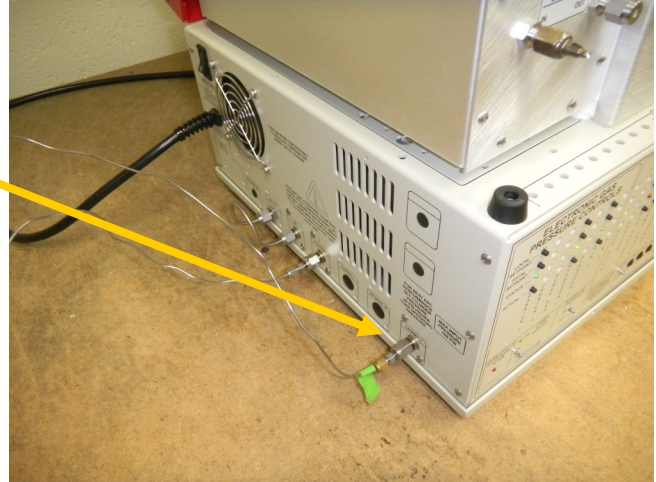

# Multiple Gas#5 GC configuration

## Jan 2016

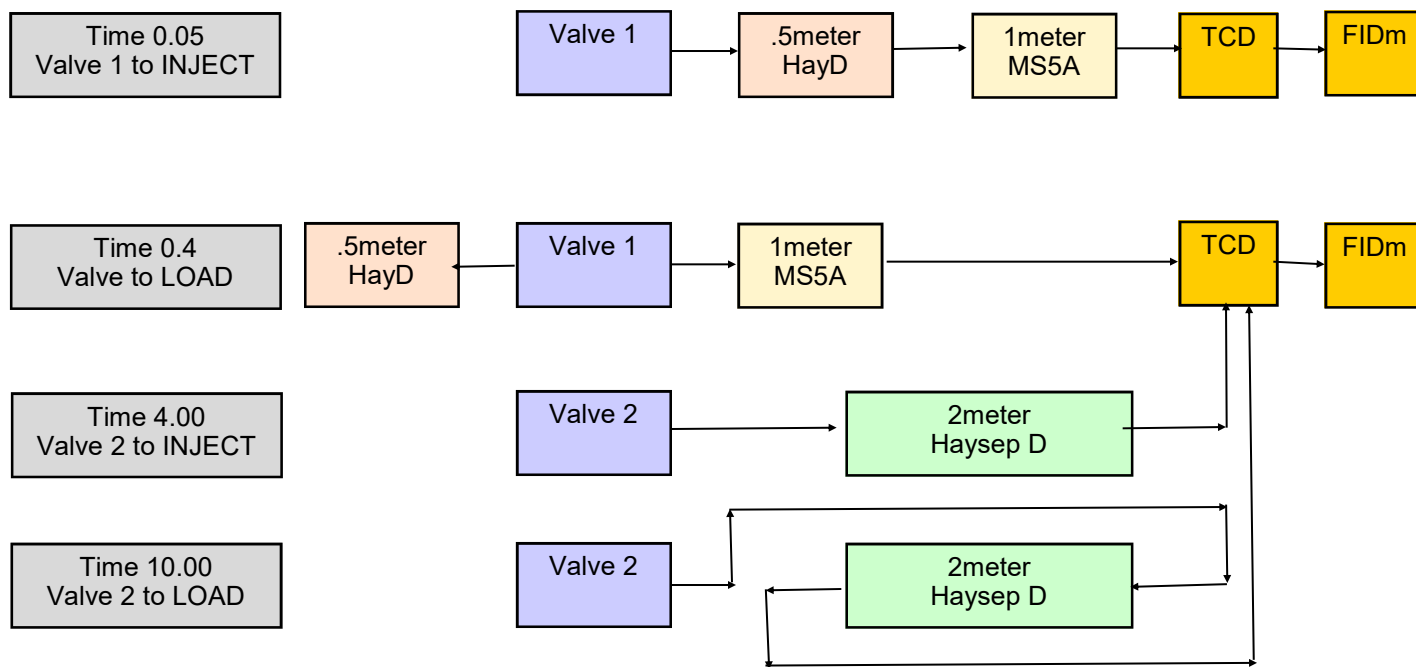

The schematic above shows the 4 steps in the MG5 analysis after the sample has been loaded into the loop of each valve.

**STEP 1:** Valve1 is turned to the INJECT position ( Relay G on ). The carrier gas pushes the sample out of the valve loop onto the 5.meter Haysep D column. H<sub>2</sub>, O<sub>2</sub>, N<sub>2</sub>, CH<sub>4</sub> and CO migrate through the .5meter HayD column very quickly and land on the 1meter MS5A column.

**STEP 2:** Valve1 is turned back to the LOAD position ( Relay G off ). Carrier gas continues to push the H<sub>2</sub>, O<sub>2</sub>, N<sub>2</sub>, CH<sub>4</sub> and CO molecules through the MS5A column towards the detectors. Also carrier gas backflushes any remaining molecules backwards through the .5meter HayD column out to vent ( not through the detectors ). The molecules which remain on the .5meter column are CO<sub>2</sub>, Water, and C<sub>2</sub> and higher hydrocarbons. These molecules would get stuck on the MS5A column if they were allowed onto the MS5A column. However, they easily backflush out of the HayD.

**STEP 3:** Valve2 is turned to the INJECT position ( Relay F on ). The carrier gas pushes the molecules in the loop of Valve2 onto the 2meter HayD column in the "forward" direction. H<sub>2</sub>, O<sub>2</sub>, N<sub>2</sub> and CO elute from the column very quickly as one peak, followed by the CH<sub>4</sub> peak, the CO<sub>2</sub>, water and the hydrocarbons from C<sub>2</sub>-C<sub>6</sub>.

**STEP 4:** At some point in the analysis Valve2 is returned to the LOAD position. This reverses ( back-flushes ) the flow direction in the HayD column. Any peaks which have not yet exited the HayD column now back out of the column and into the detector. If, for example the analysis had no peaks after CO<sub>2</sub> ( or you did not care about any peak after CO<sub>2</sub> ), then you would backflush after the CO<sub>2</sub> peak. Any peaks remaining in the HayD column would come out in a "lump".

# Multiple Gas#5 GC configuration

## Jan 2016

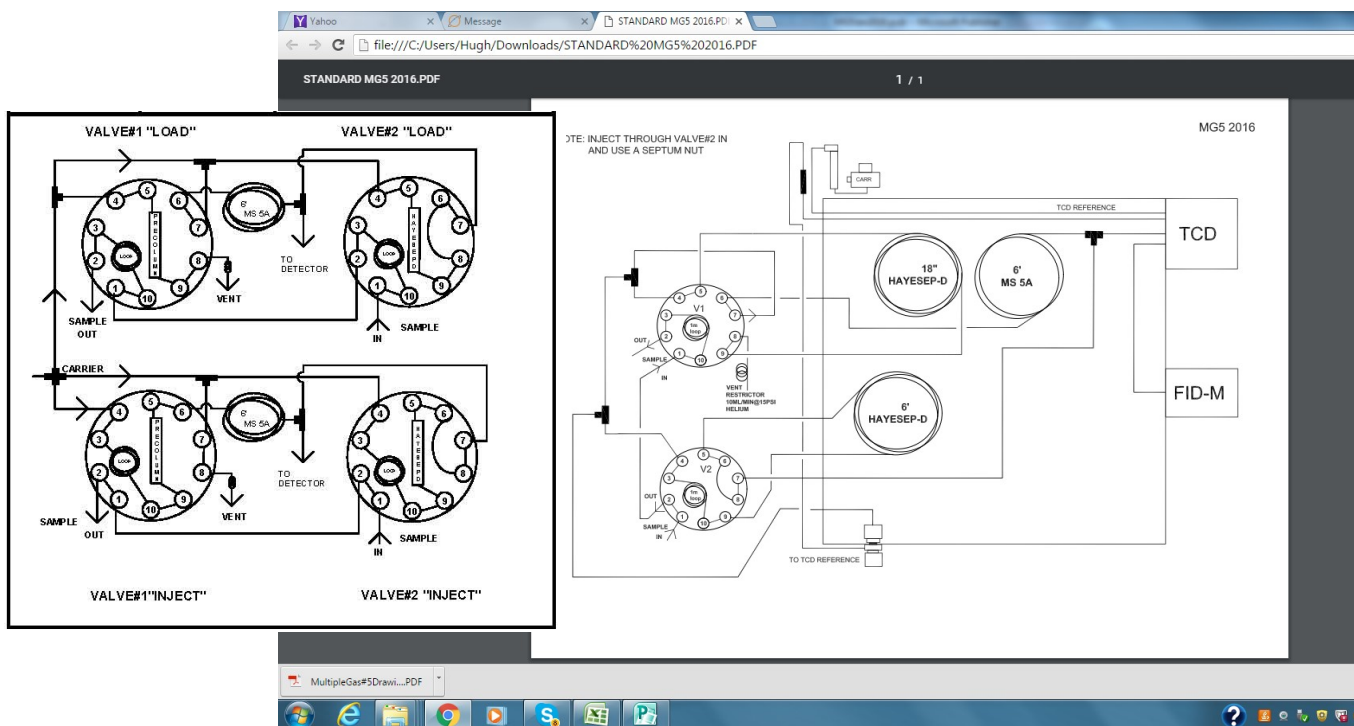

The diagram above shows a schematic of the "basic" MG#5 configuration with both valves in the INJECT position. A similar diagram below shows the "basic" MG#5 plus an additional column and FPD/FID detector to measure sulfur gases like H<sub>2</sub>S, CO<sub>2</sub>, SO<sub>2</sub>, mercaptans, DMS etc.

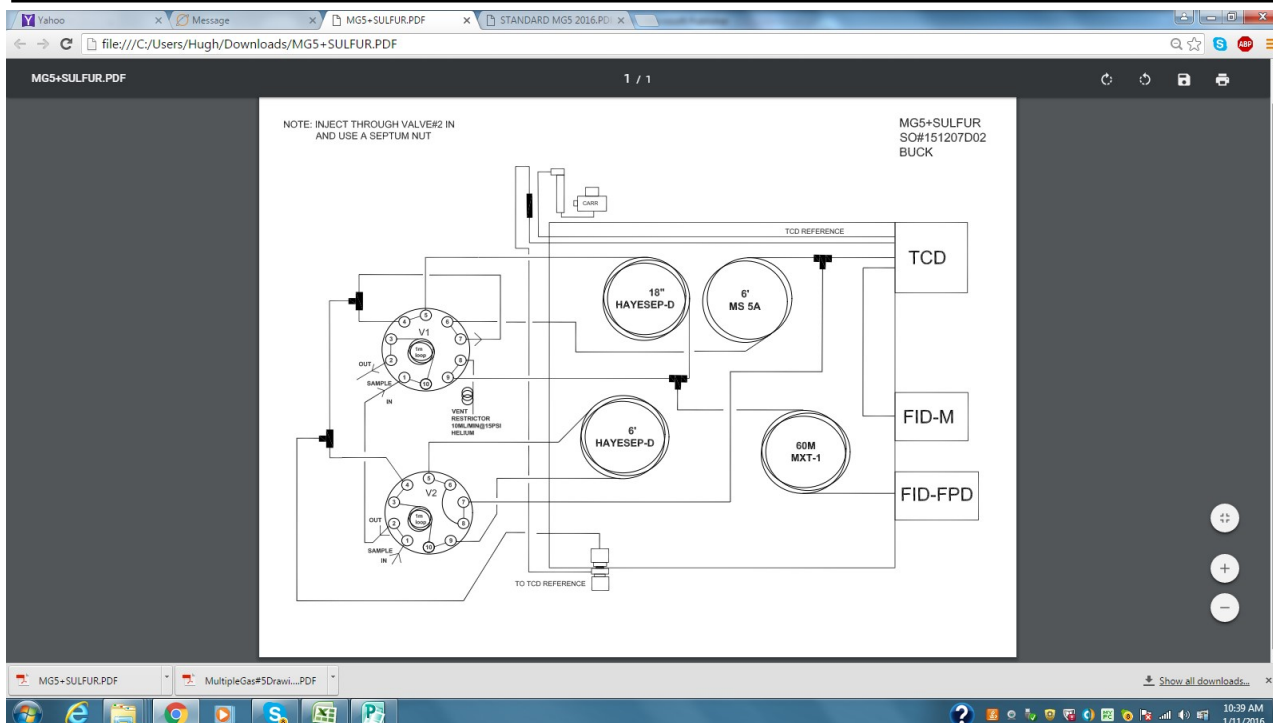

# Multiple Gas#5 GC configuration

## Jan 2016



This is a typical chromatogram of gases at 1% in Nitrogen. The FIDmethanizer chromatogram is on the top and the TCD on the bottom.

STEP 1: Valve1 is turned to the INJECT position ( Relay G on ). The carrier gas pushes the sample out of the valve loop onto the 5.meter Haysep D column. H<sub>2</sub>, O<sub>2</sub>, N<sub>2</sub> CH<sub>4</sub> and CO migrate through the .5meter HayD column very quickly and land on the 1meter MS5A column.

STEP 2: Valve1 is turned back to the LOAD position ( Relay G off ) at .4 minutes. Carrier gas continues to push the H<sub>2</sub>, O<sub>2</sub>, N<sub>2</sub>, CH<sub>4</sub> and CO molecules through the MS5A column towards the detectors. Also carrier gas backflushes any remaining molecules backwards through the .5meter HayD column out to vent ( not through the detectors ). The molecules which remain on the .5meter column are CO<sub>2</sub>, Water, and C<sub>2</sub> and higher hydrocarbons. These molecules would get stuck on the MS5A column if they were allowed onto the MS5A column. However, they easily backflush out of the HayD.

STEP 3: Valve2 is turned to the INJECT position ( Relay F on ). The carrier gas pushes the molecules in the loop of Valve2 onto the 2meter HayD column in the "forward" direction. H<sub>2</sub>, O<sub>2</sub>, N<sub>2</sub> and CO elute from the column very quickly as one peak, followed by the CH<sub>4</sub> peak, the CO<sub>2</sub>, Water and the hydrocarbons from C<sub>2</sub>-C<sub>6</sub>.

STEP 4: At some point in the analysis Valve2 is returned to the LOAD position. This reverses ( back-flushes ) the flow direction in the HayD column. Any peaks which have not yet exited the HayD column now back out of the column and into the detector. If, for example the analysis had no peaks after CO<sub>2</sub> ( or you did not care about any peak after CO<sub>2</sub> ), then you would backflush after the CO<sub>2</sub> peak. Any peaks remaining in the HayD column would come out in a "lump".

# Multiple Gas#5 GC configuration

## Jan 2016

The screen at right shows the oven temperature program used.

STEPS 1 and 2 occur while the column oven is at 50C. After 1 minute, the column temperature increases to 90C and stays there until after STEP 3. Then the column temperature increases to 270C.

At some point while the column temperature increases, STEP 4 occurs, backflushing any un-eluted molecules.

The channel 1 Event table is shown at right.

At time 0.05 Relay G turns on. This initiates STEP 1.

At time 0.4, Relay G turns off.

At time 4.00 Relay F turns on initiating STEP 3.

At time 8.0 Relay F turns off backflushing the Haysep D column to the detectors.

The exact times may change if the carrier flow rate changes or if a different carrier gas is used. The backflush time ( STEP 4 ) especially may change depending on what molecules are in the sample.

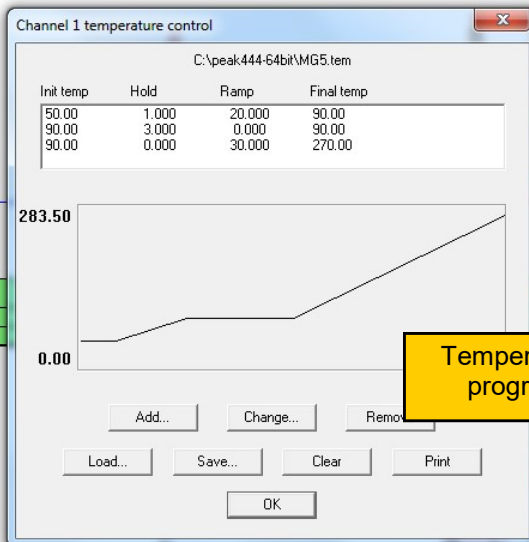

Time	Event
0.000	ZERO
0.050	G ON (Valve1)
0.400	G OFF (Valve1)
4.000	F ON (Valve2)
8.000	F OFF (Valve2)



# Multiple Gas#5 GC configuration

## Jan 2016

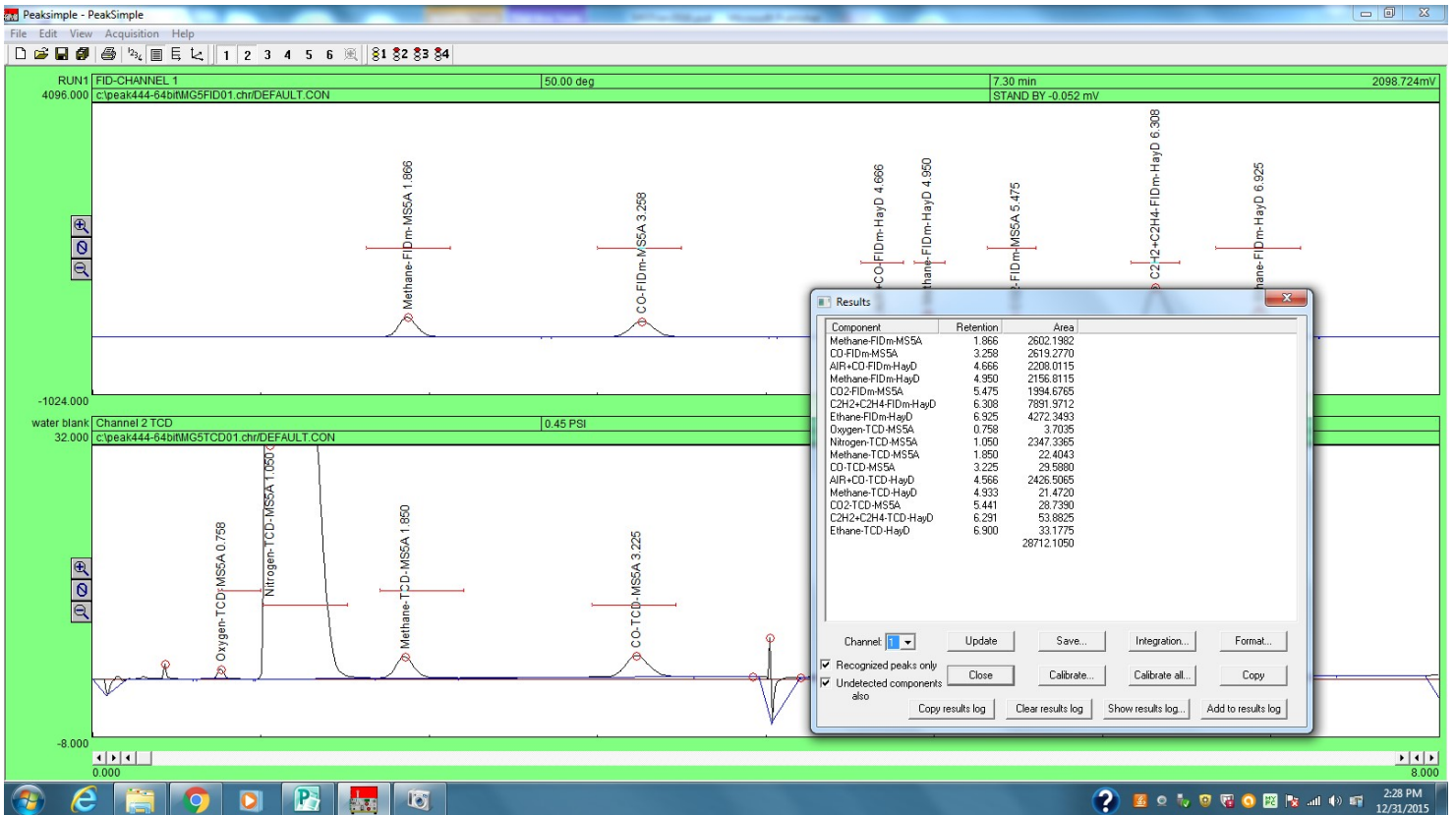

The sample above ( helium carrier at 15psi ) shows 1% each methane, CO, CO<sub>2</sub>, ethane, ethylene and acetylene with a little oxygen, and nitrogen balance. Note that the area of the methane, and CO peaks are about the same on the FIDm, and similar but not identical on the TCD.

This shows that the methanizer is working 100% since every molecule of CO is converted to one molecule of methane.

It also shows that the Valve 1 timing ( Relay G off at .4 minutes ) is correct.

Methane and CO have different thermal conductivities so on the TCD the peak areas are slightly different from each other.

Note that on a HaysepD column, ethylene and acetylene co-elute. A different flavor of Haysep ( Haysep N for example ) can be substituted to separate these two molecules.

# Multiple Gas#5 GC configuration

## Jan 2016

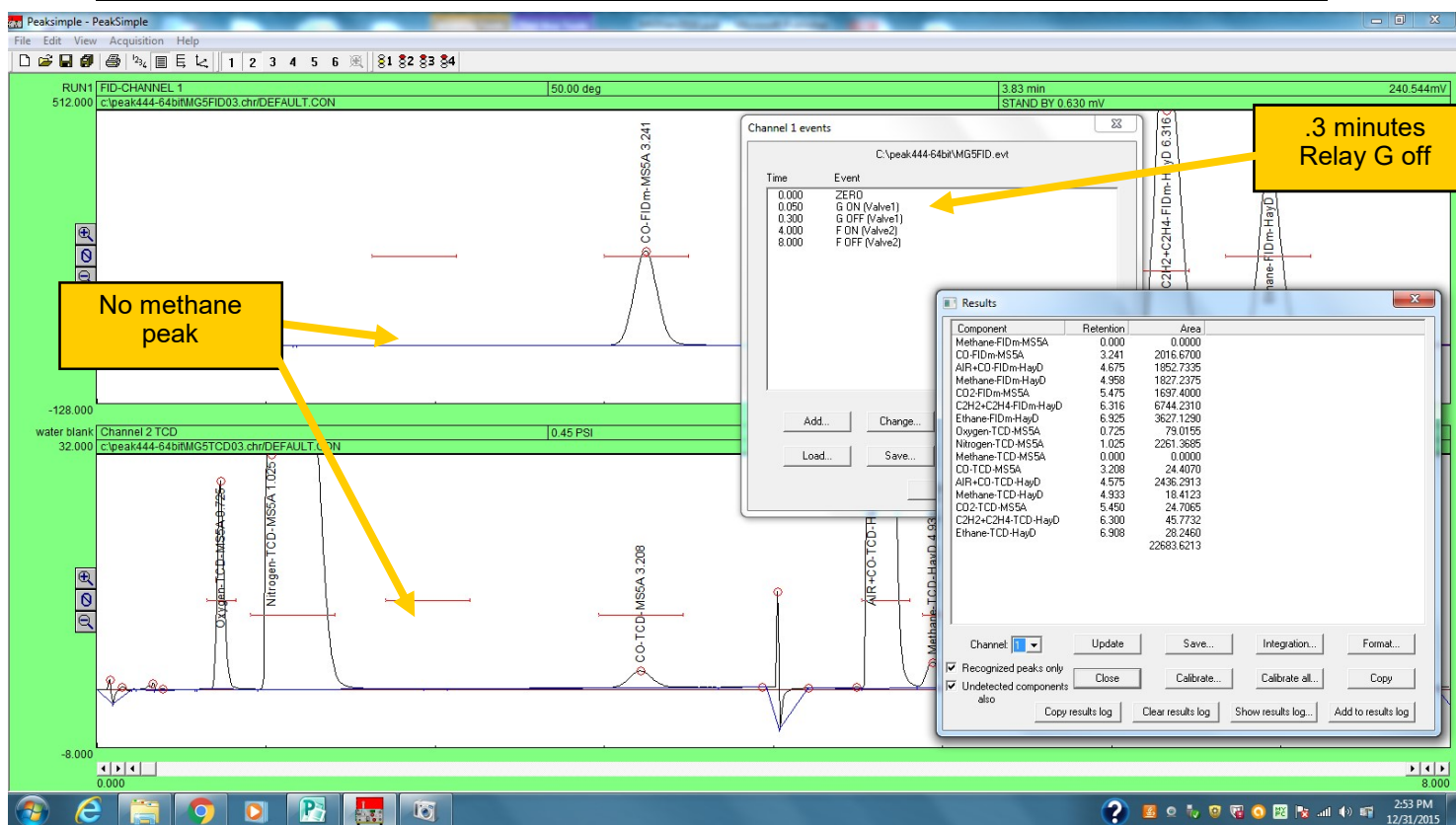

Compare the same sample but with Relay G off at .3 minutes instead of .4 minutes as in the previous page. The methane peak has disappeared because the time that Relay G turned off was too early, so the methane peak did not make it onto the MS5A column and was back-flushed off the pre-column ( .5meter HayD ) to vent.

If you change carrier gas types ( argon instead of helium ), carrier flow rates, column types ( MS13X instead of MS5A ), or column lengths, you will have to determine the correct timing by trial and error.

# Multiple Gas#5 GC configuration Jan 2016

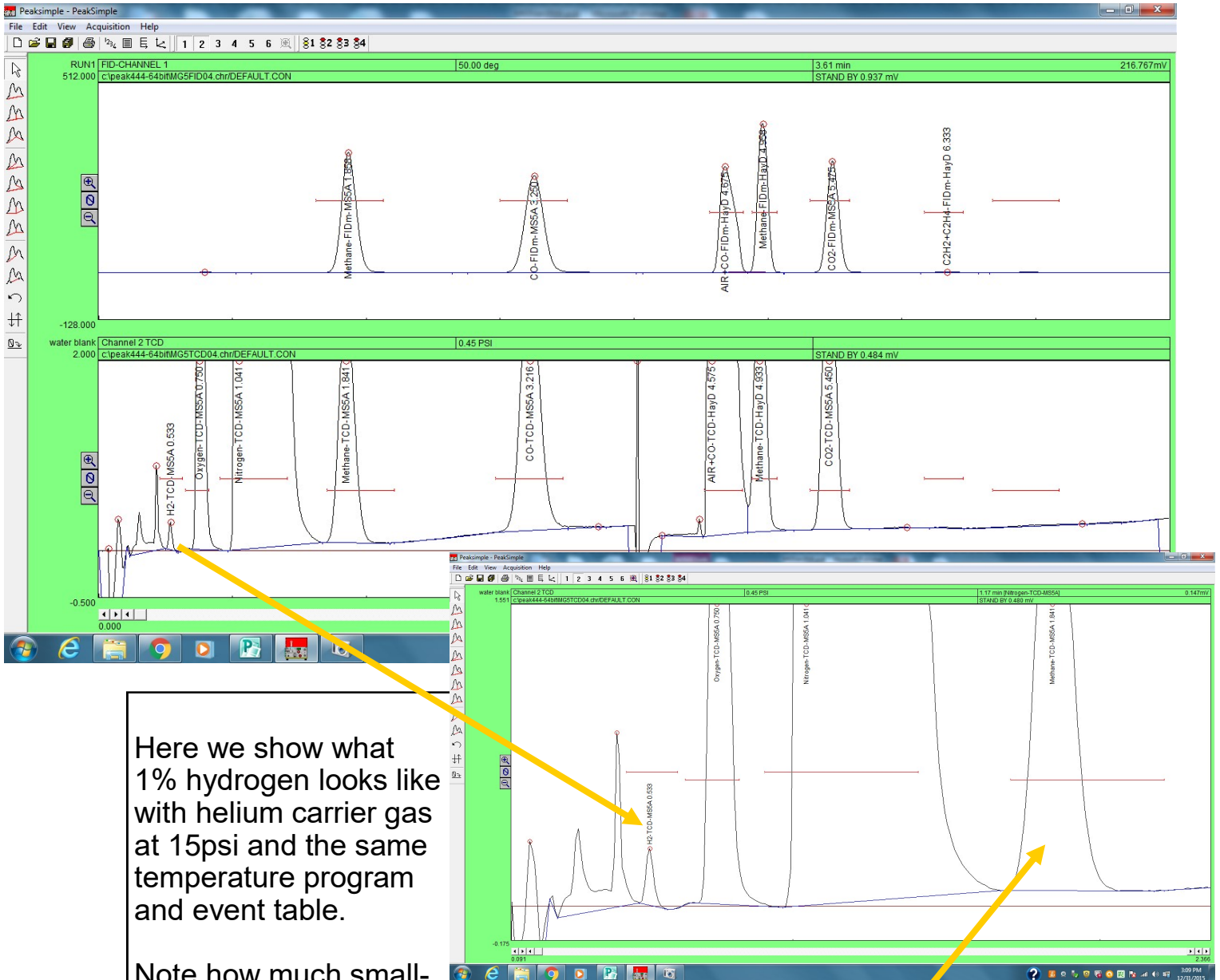

Here we show what 1% hydrogen looks like with helium carrier gas at 15psi and the same temperature program and event table.

Note how much smaller the 1% hydrogen peak is than the 1% methane peak.

# Multiple Gas#5 GC configuration Jan 2016

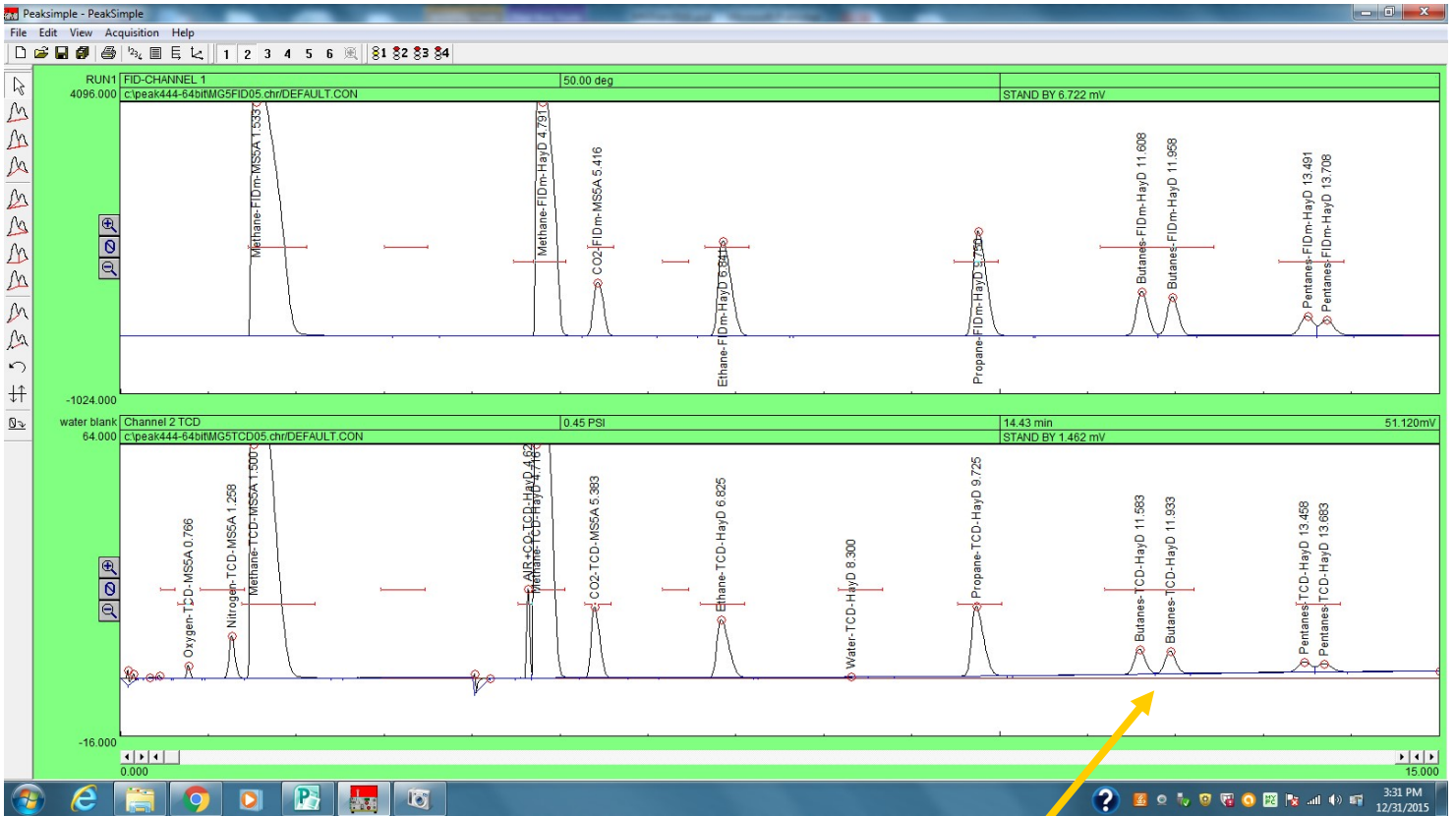

This is natural gas. Notice there is no CO, but plenty of butanes and pentanes. There is also a water peak on the TCD.

# Multiple Gas#5 GC configuration Jan 2016

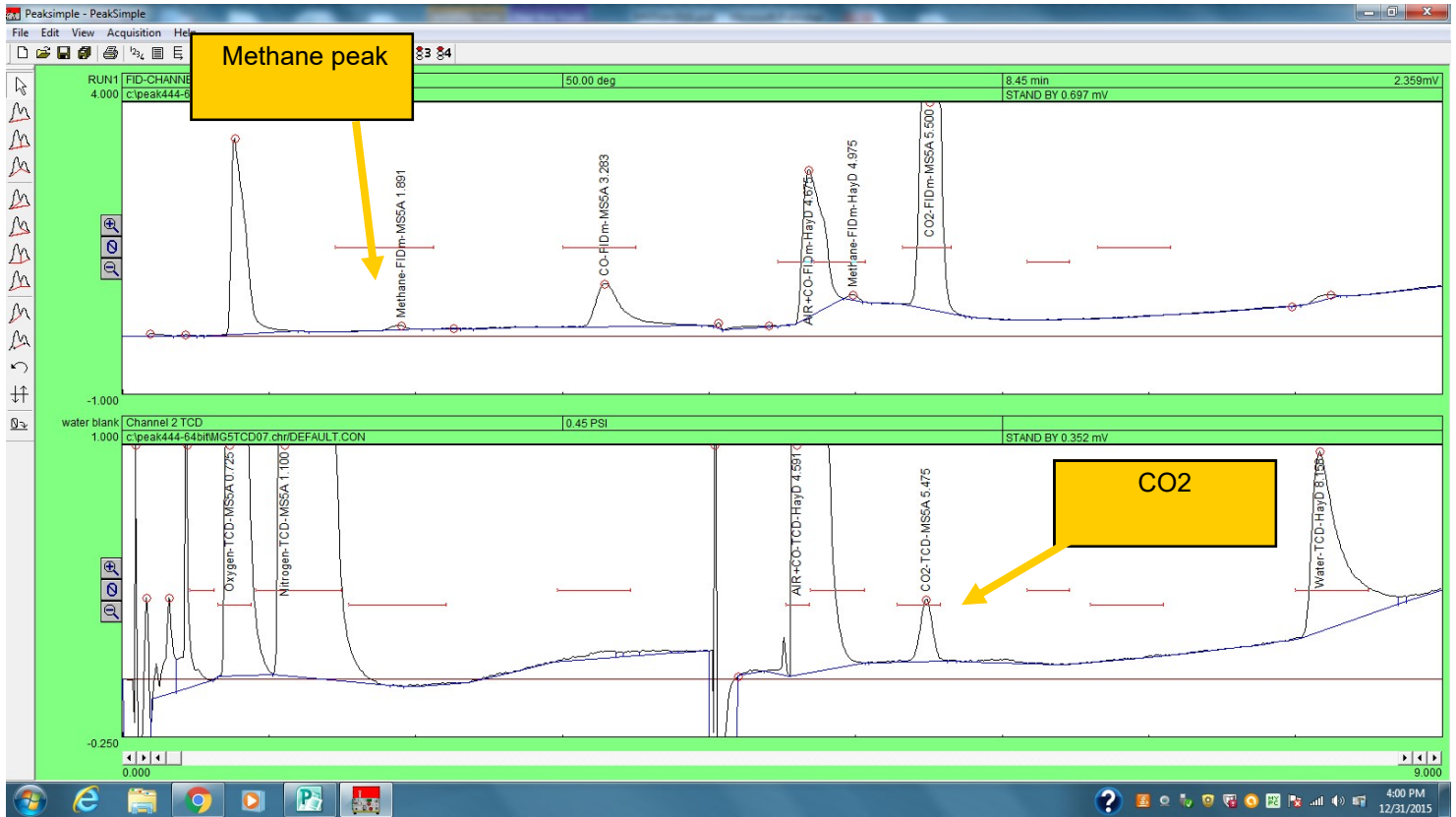

This is room air which has 2ppm of methane, 400ppm of CO<sub>2</sub> and 10,000ppm of water.

Notice the 2ppm methane peak is easily detectable on the FIDmethanzier, and the 400ppm CO<sub>2</sub> peak easily detectable on the TCD.

The room air in this case also apparently had some CO.

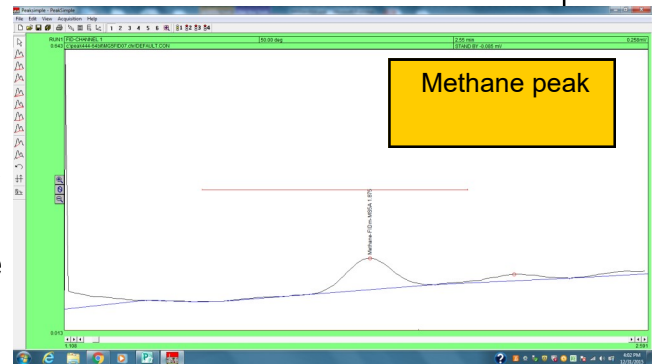

# Multiple Gas#5 GC configuration Jan 2016

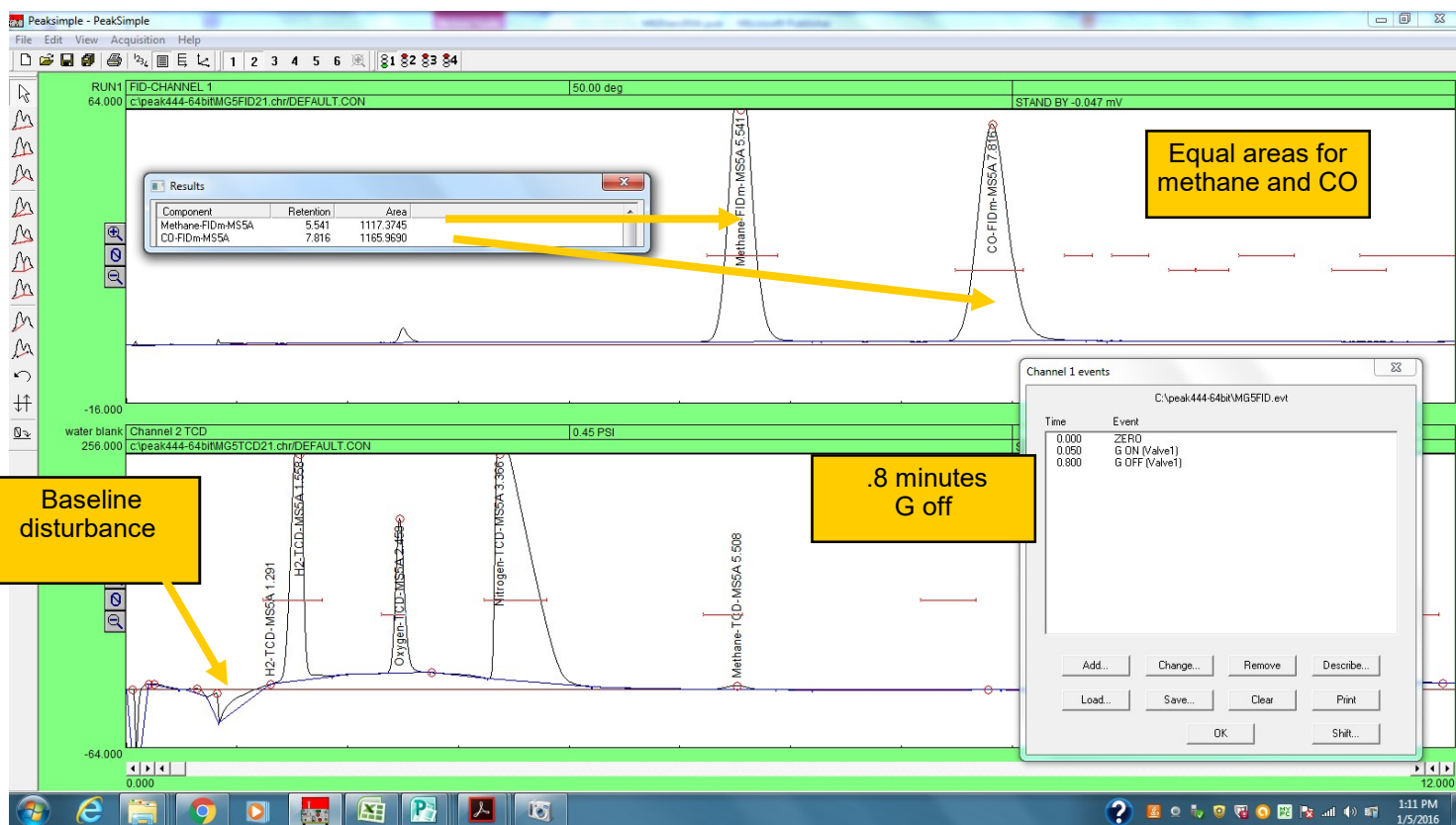

If hydrogen measurement is a priority its is best to use Argon carrier gas instead of helium. Because there is an un-avoidable baseline disturbance when Relay G turns off and backflushes the pre-column, it may make sense to use a 6 foot MS5A column instead of the 3 foot MS5A column. The 6' column makes the Hydrogen peak come out a little later giving the baseline a chance to stabilize before the H2 peak begins.



6' and 3' MS5A columns

# Multiple Gas#5 GC configuration

## Jan 2016

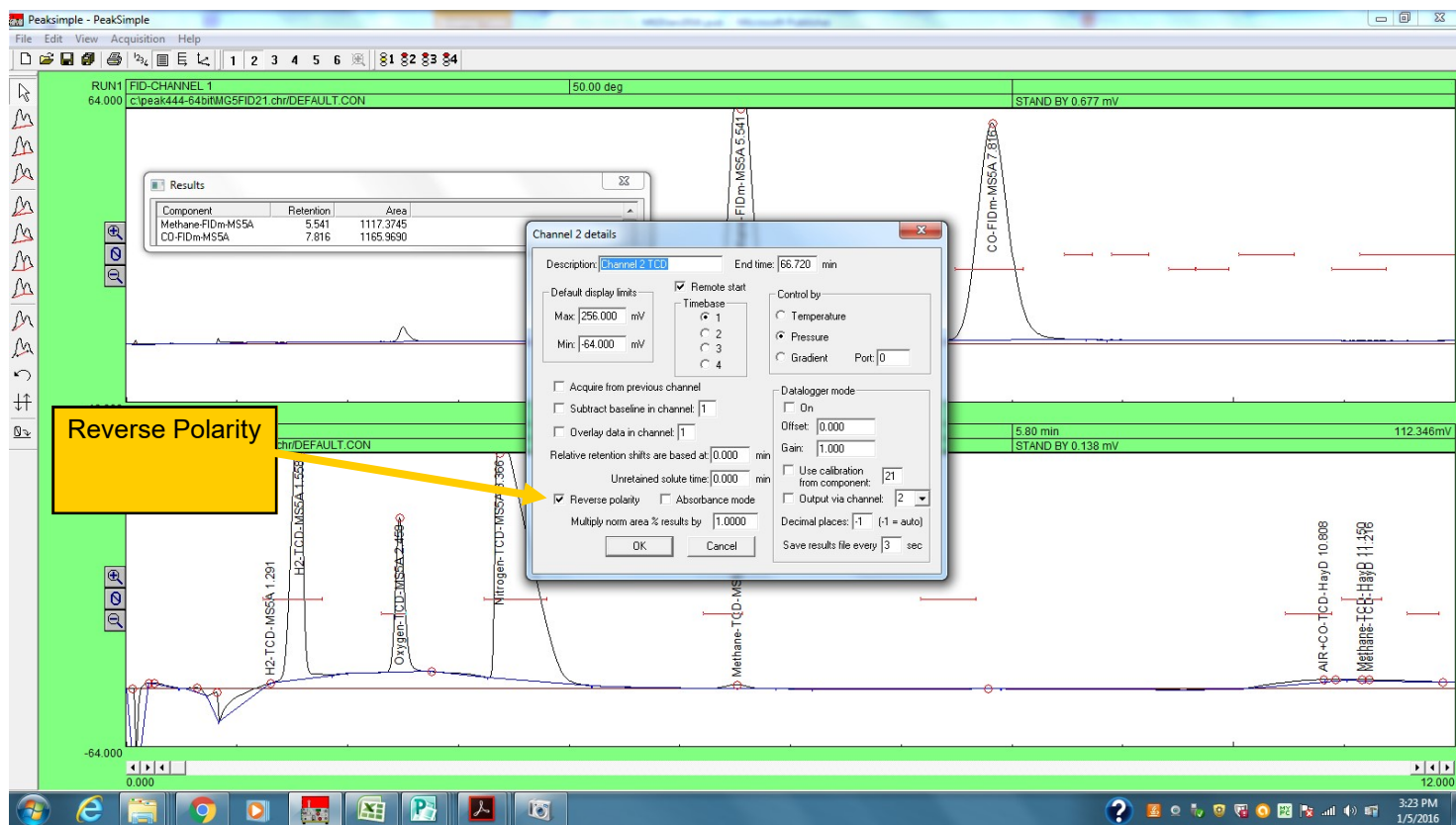

When using Argon or Nitrogen carrier gas the peaks come out upside down. In the channel 2 Details screen, click the box labelled "Reverse Polarity" so the peaks will come out in the positive direction.

# Multiple Gas#5 GC configuration Jan 2016

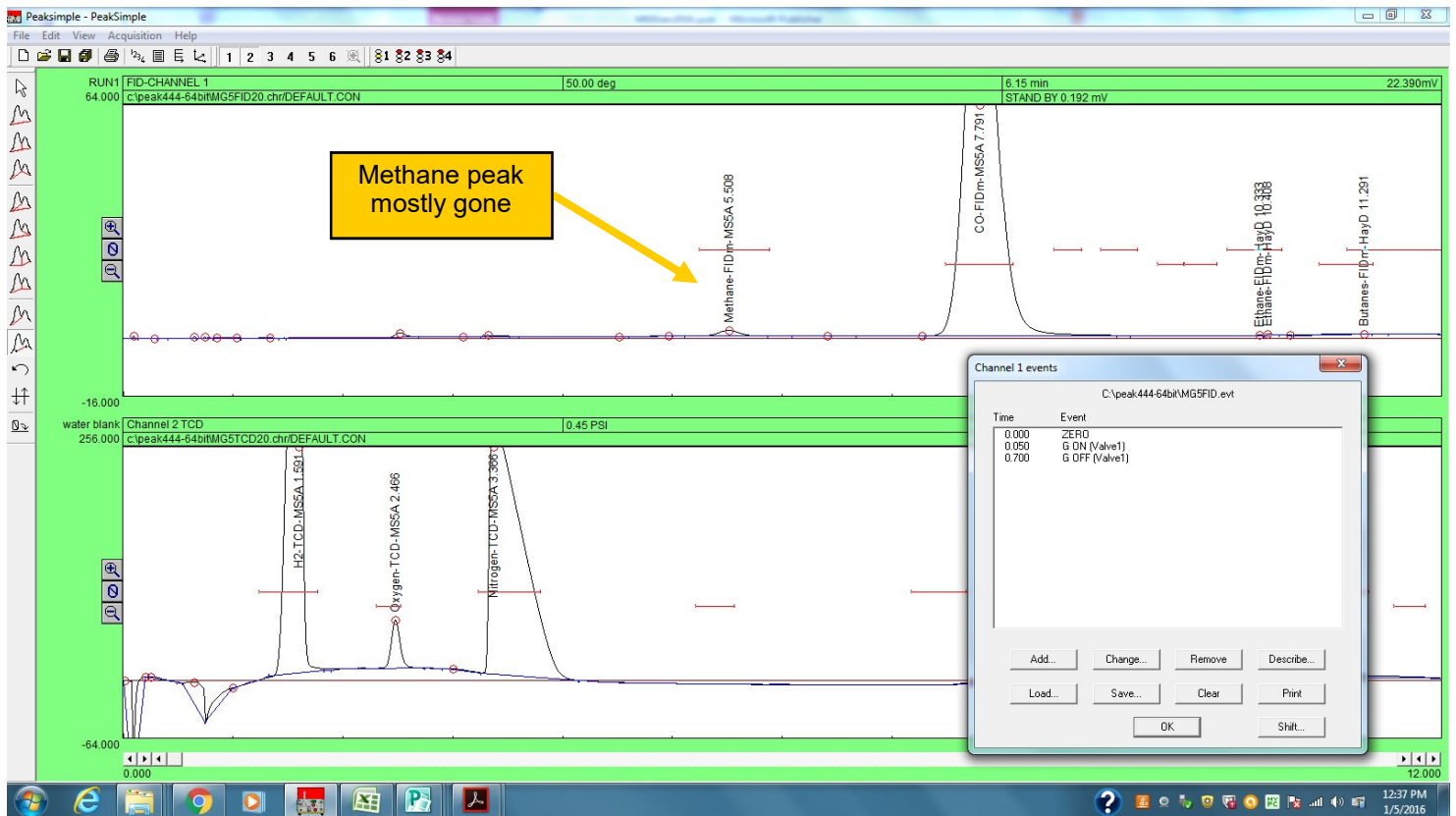

The exact time for Relay G off ( backflush pre-column ) will be different using Argon vs Helium. By trial and error move the Relay G off time earlier and earlier until you see the methane peak disappear.

Compare this analysis to the same analysis on page 13.

Both methane and CO are present in the sample at 1% and have similar area count in the page 13 analysis with Relay G off set to .8 minutes.

In the analysis above the Relay G off time is .7 minutes which was early enough to backflush the methane peak ( which was still on the pre-column ) , yet allow the CO peak to make it through onto the MS5A column.



# Multiple Gas#5 GC configuration

## Jan 2016

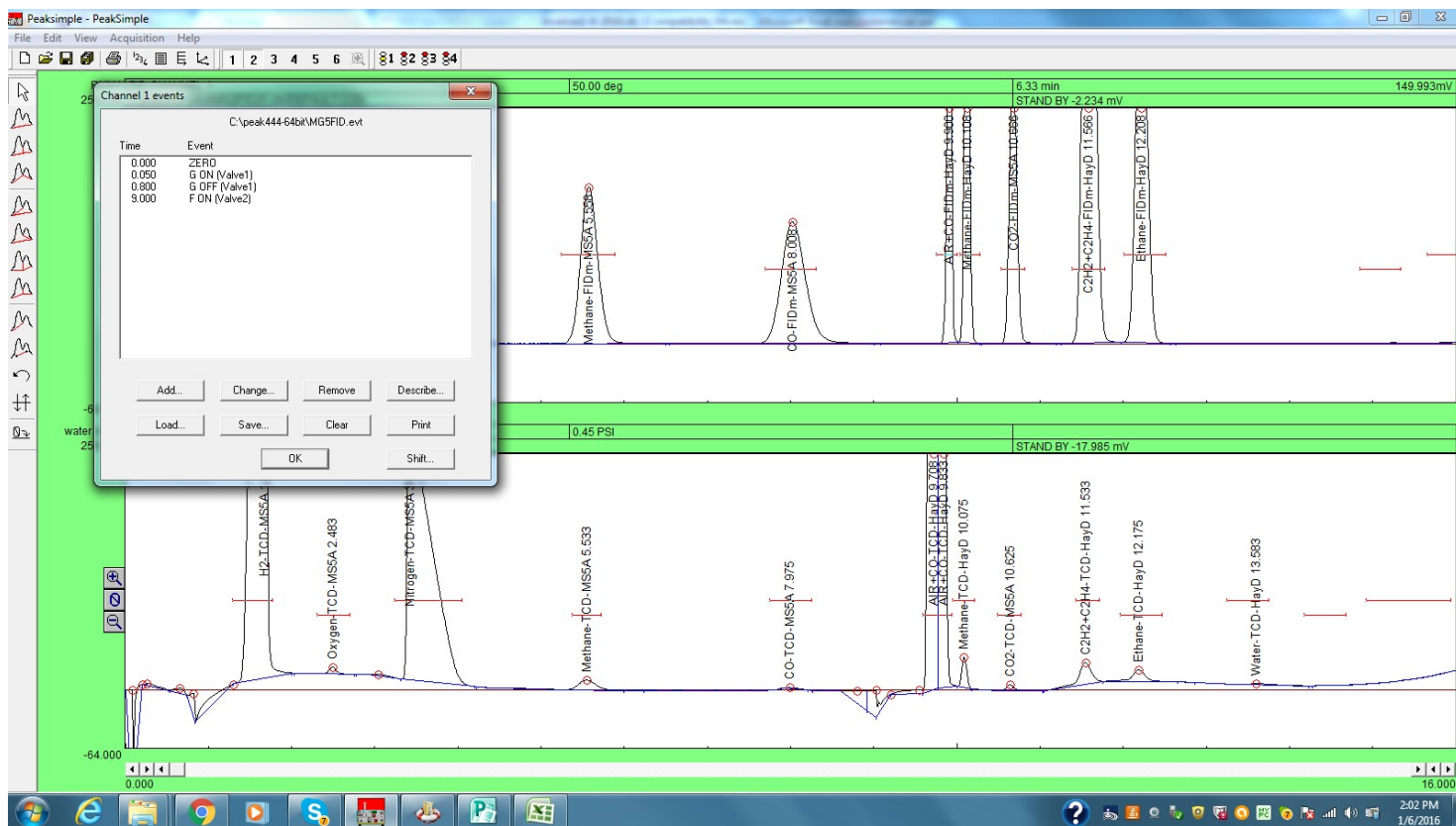

The chromatogram above shows the full analysis including the C2 peaks. Note that the Relay F on time ( inject onto the Haysep column ) had to be delayed until 9 minutes to allow the CO to elute from the 6'MS5A column before making the injection onto the Haysep column.

# Multiple Gas#5 GC configuration

## April 2016

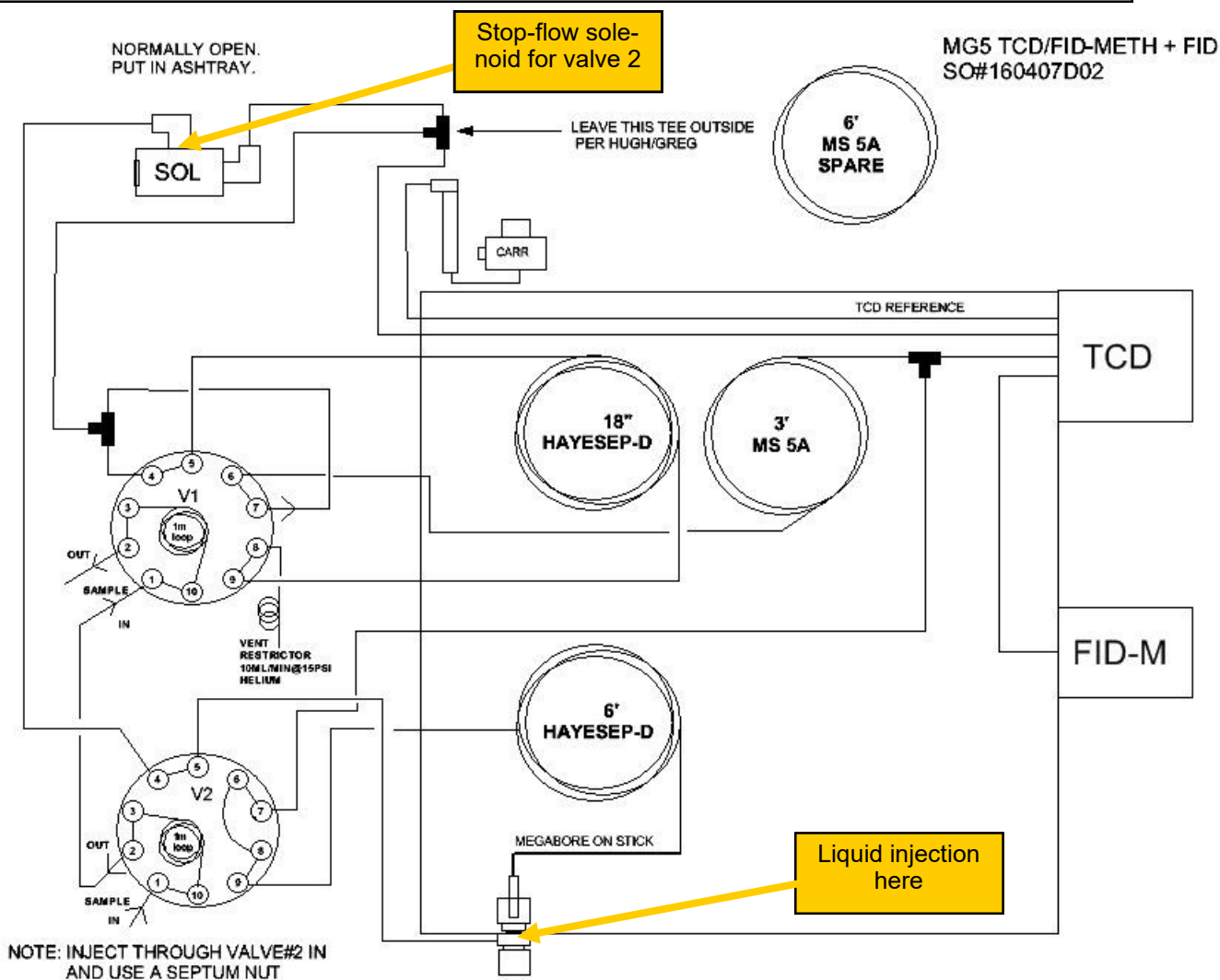

Starting in March of 2016 all MG5 configurations were slightly modified:

- 1) The Haysep D column ( and sometimes a capillary column ) are connected to the injector port to make it easy to perform a liquid injection or small volume gas injection **without** using the gas sampling valves, and without having to reconnect columns inside the column oven. The low volume or liquid injection can only be made into the Haysep column, not the MoleSieve.
- 2) A solenoid valve can interrupt the carrier gas to the Haysep valve and column. This allows both valves to inject at the same time if that is critical to the analysis ( the normal MG5 valve sequence injects valve 1 immediately, and valve 2 some minutes later ). When injecting both valves simultaneously, the solenoid is closed ( Relay A ON usually ) just after the valve injection to stop-flow the peaks in the Haysep D column until the MoleSieve peaks have eluted. An example of this is shown later in this document.

# Multiple Gas#5 GC configuration April 2016

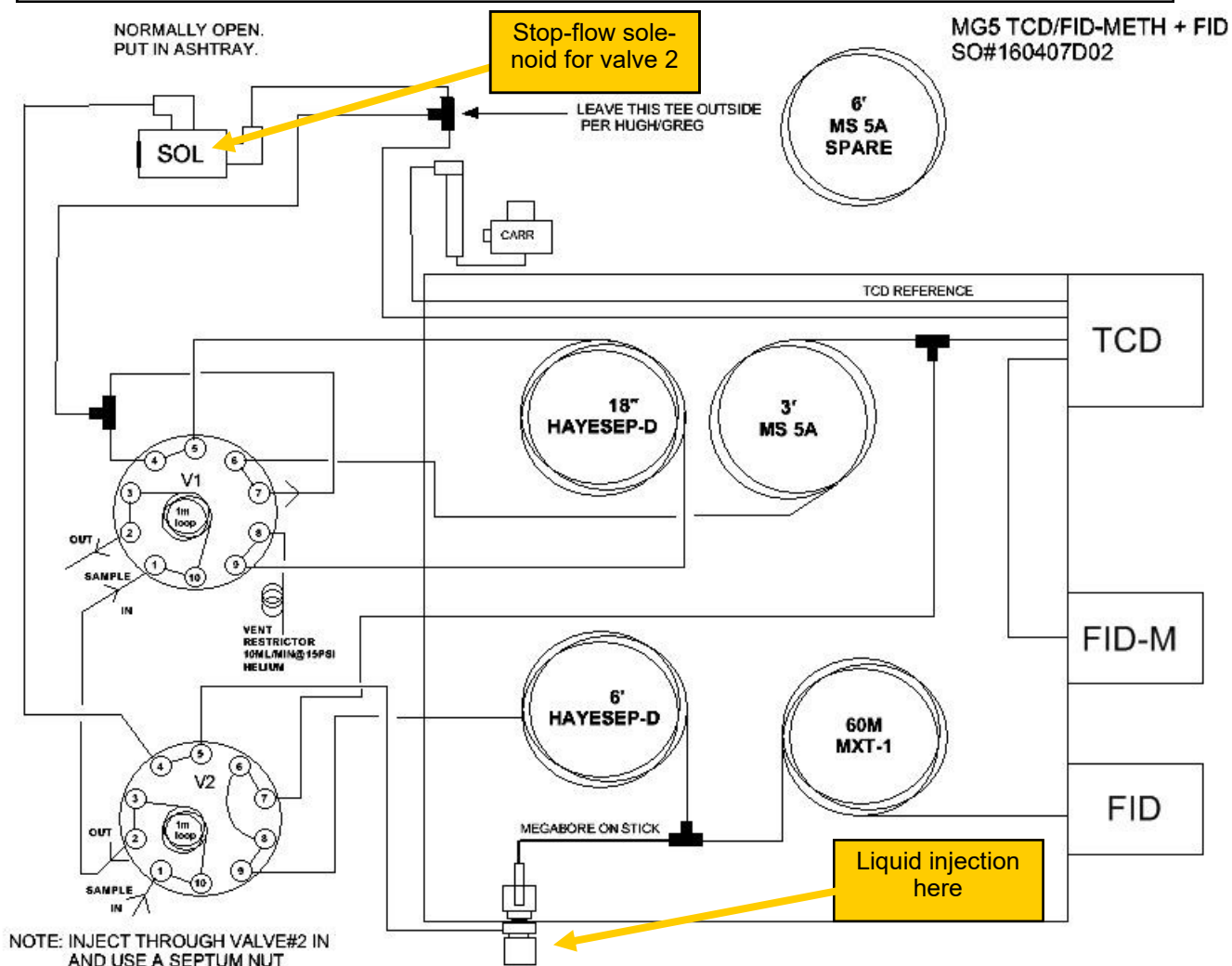

This drawing shows a capillary column and extra FID detector connected at a "tee" fitting so a liquid injection ( or low volume gas injection ) splits onto the capillary and the Haysep column.

In this configuration neither Valve 1 or Valve 2 is actuated at the beginning of the analysis. Valve 2 may optionally be rotated to the Inject position to backflush the Haysep column after the capillary peaks have eluted. See next page.

# Multiple Gas#5 GC configuration April 2016

When a capillary column is configured along with the Haysep column it can be connected at one of two places. Here it is shown connected to a “tee” fitting where one leg of the tee is the capillary column, the second leg is the Haysep column and the third leg is connected to the on-column injection port using a small adapter.

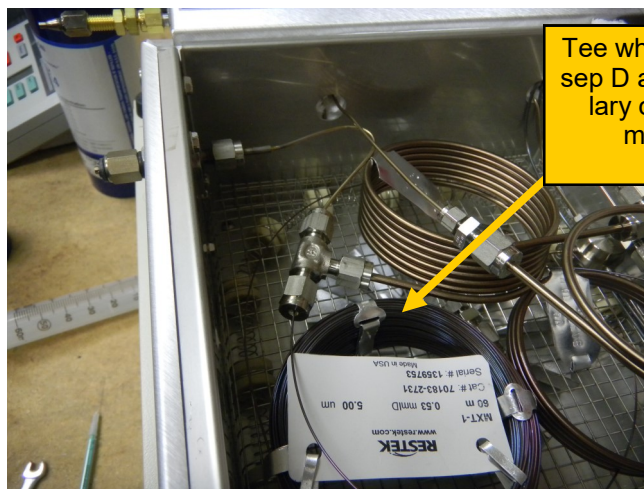

Tee where Haysep D and capillary column meet.

When making a low volume gas injection you do not need to use the gas sampling valves at all, unless you want to backflush the Haysep column after the capillary peaks have eluted.

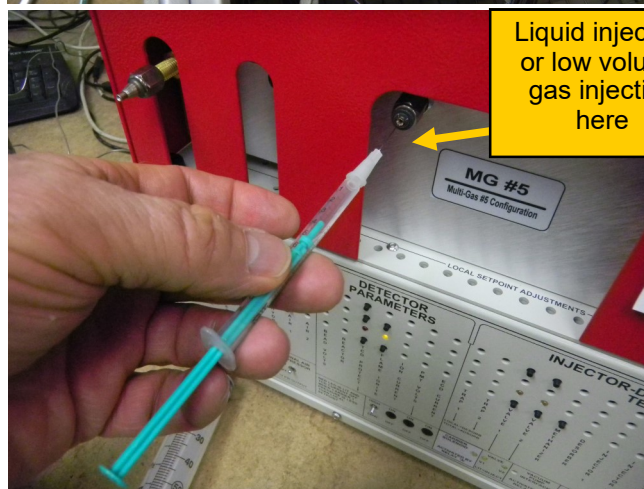

Liquid injection or low volume gas injection here

Here is a chromatogram of C1-C6 hydrocarbons injected via a gas tight syringe and backflushed at 6 minutes after all the peaks had eluted from the capillary column.

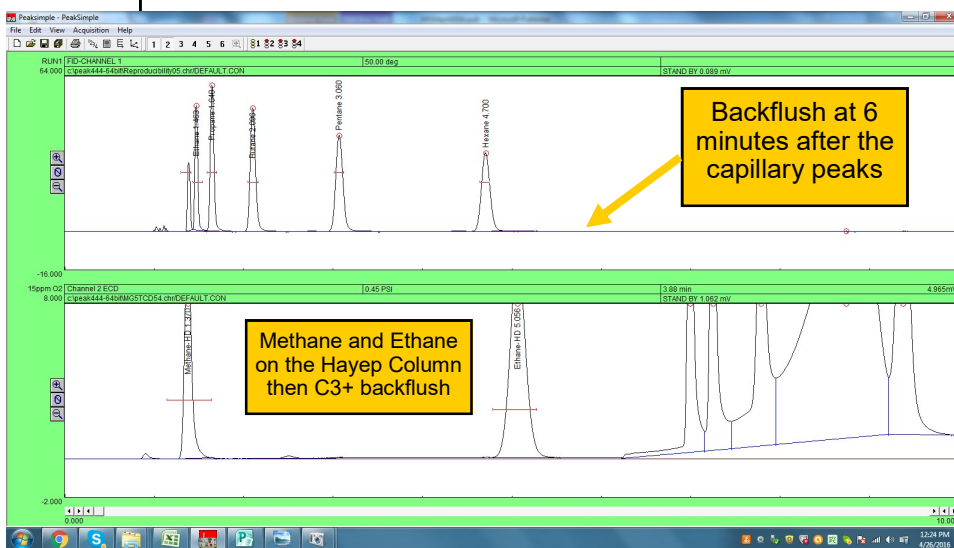

If you need to quantitate the backflush, the gas sampling valve loop must have a carrier gas purge to avoid injecting peaks which might be in the loop. See the diagram to understand.

# Multiple Gas#5 GC configuration April 2016

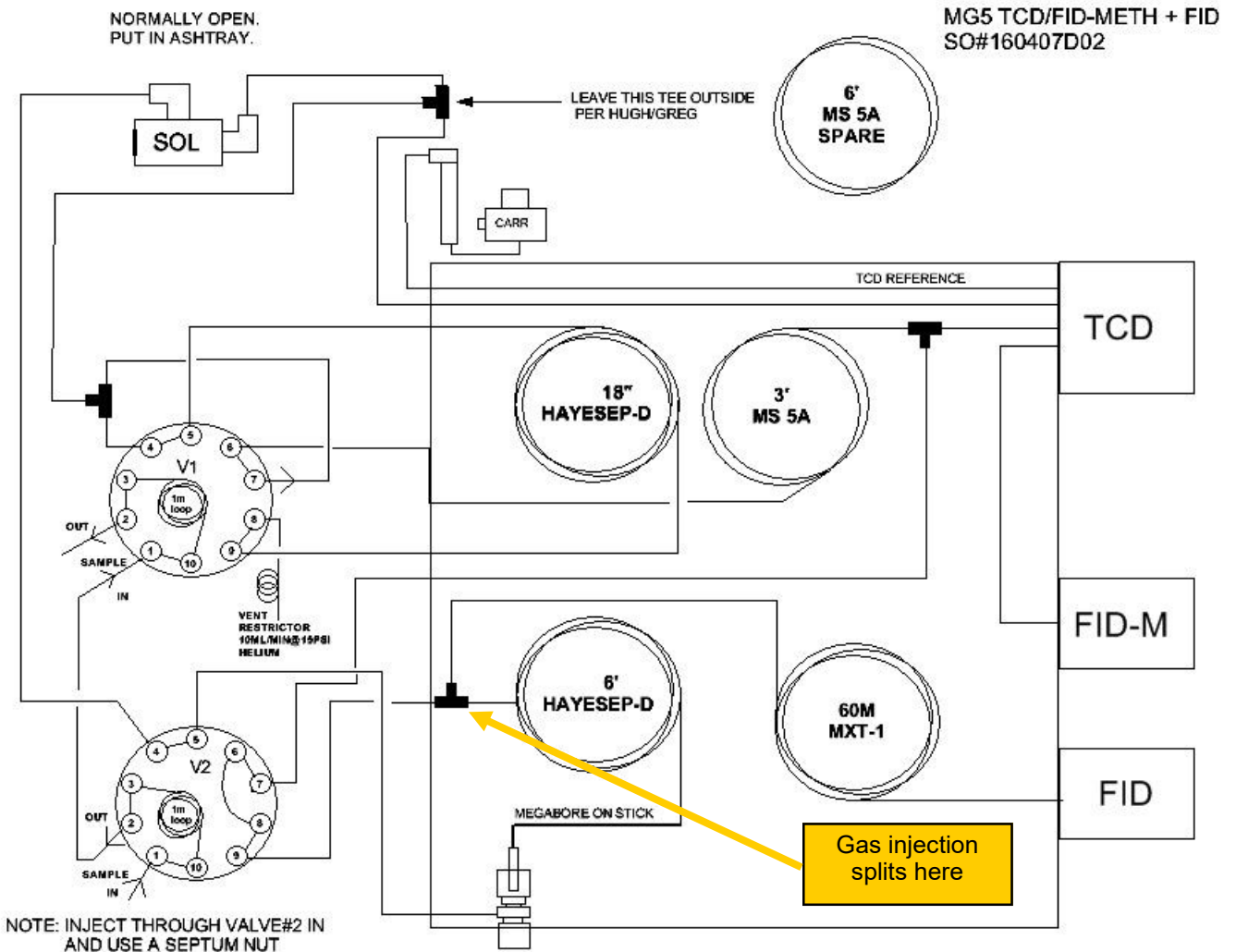

- 1) This drawing shows a capillary column set up for gas injection from the gas sampling valves onto both the Haysep and capillary column.

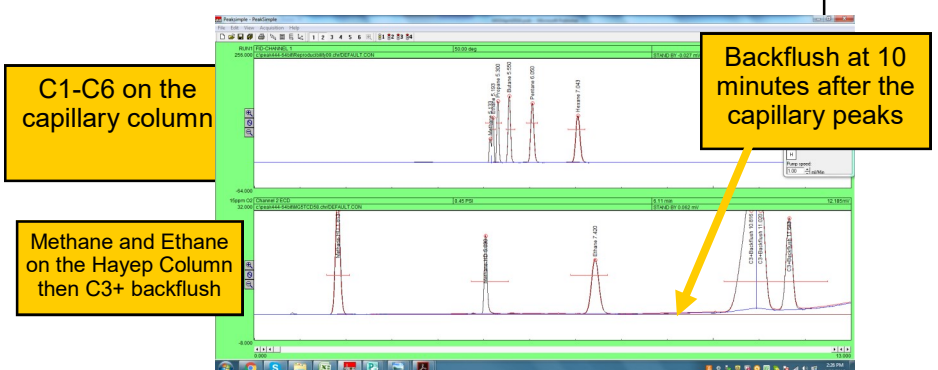

# Multiple Gas#5 GC configuration April 2016

There are some applications where the time delay between injecting the sample in Valve1 and Valve2 is important and un-desirable.

The top chromatogram shows the normal MG5 valve sequence/event table. The sample was 1000ppm C1-C6 aliphatic hydrocarbons. V1 injects at .1minutes. V2 injects at 4 minutes.

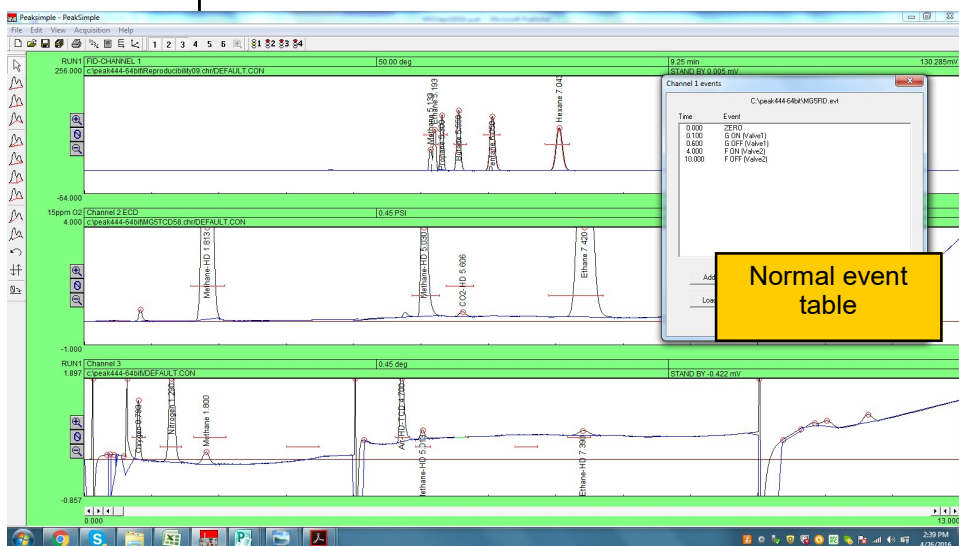

This chromatogram shows the same sample but with Valve 1 and 2 injected simultaneously. Relay A is turned ON at the same time (.1minute) which stops the carrier gas flow in the Haysep and capillary columns. This creates some extra "ghost" peaks but does not substantially affect the analysis. The stop-flow solenoid is turned OFF (re-establishing the flow) at 4minutes.

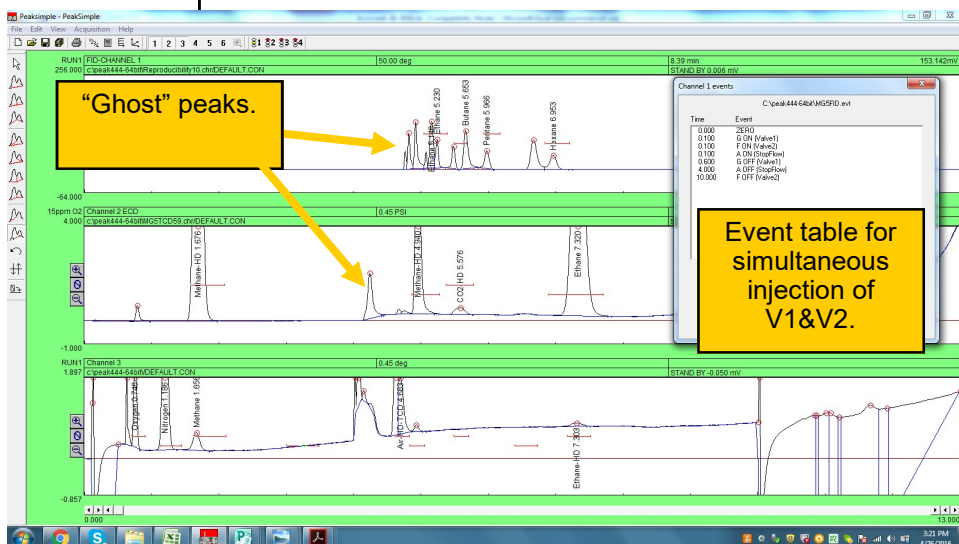

# Multiple Gas#5 GC configuration October 2022

A number of improvements have been made to the popular MultipleGas#5 GC configuration.

There are two on-column injectors provided so small volume injections may be made into either the 6' Haysep D column or the MS5A column with the 18" Haysep D pre-column. Small volume injections are useful when there is not enough sample ( 10ml ) to flush the sample loops.

The MS5A column has been standardized at 4.5 feet where before it was either 3 or 6 foot.

The methanizer catalyst tube has been enlarged so there is about 10X more catalyst than previously. The Large Capacity Methanizer is much more resistant to sulfur poisoning.

There are now two carrier gas controls instead of the previous single Carrier EPC. The independent carrier control allow columns of different lengths to be installed without affecting the other columns in the system.

If for example a 2 foot long MS5A were installed in place of the 4.5' column, the single EPC control would have resulted in a much faster carrier gas flow rate through the MS5A and a slower than optimum flow rate through the 6' Haysep D.

With the independent controls, the flow through each column can be optimized.

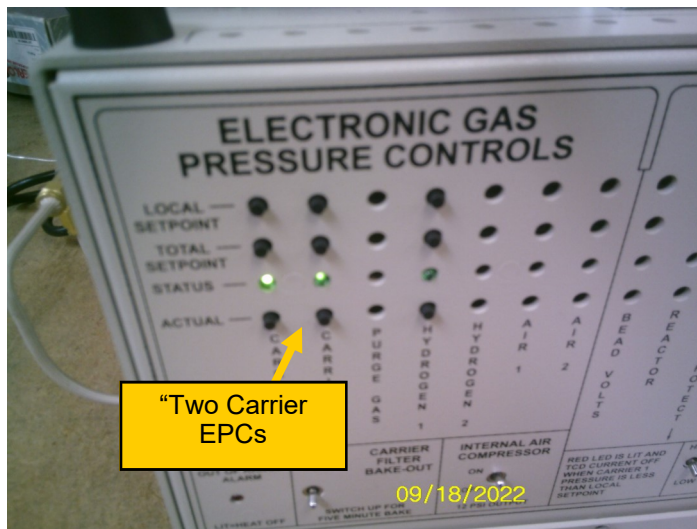
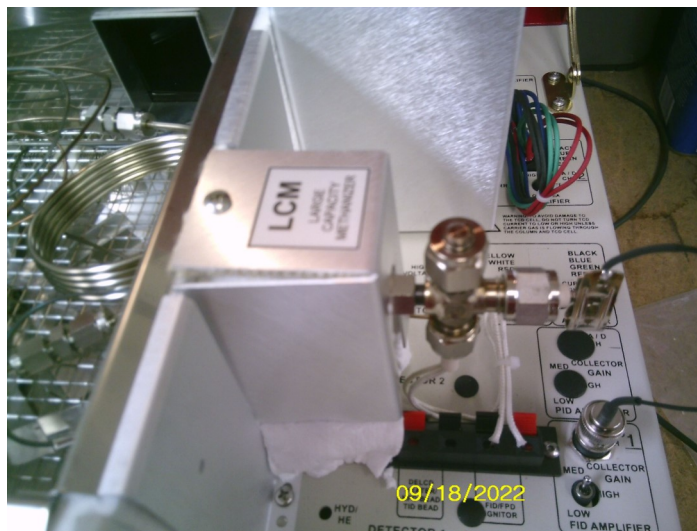
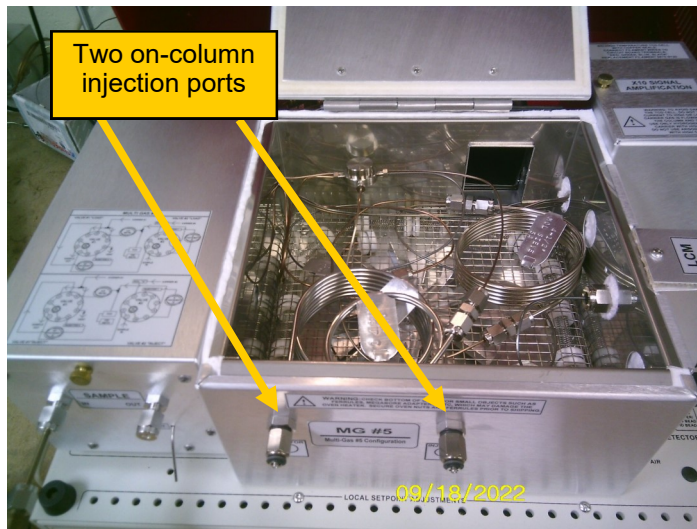

# Multiple Gas#5 GC configuration October 2022

Typically ( but not necessarily ) the two carrier gases would be the same type of gas ( argon, nitrogen, helium or hydrogen ). The gas shown here is connected to a tee which feeds both carrier gas inlets on the GC left side.

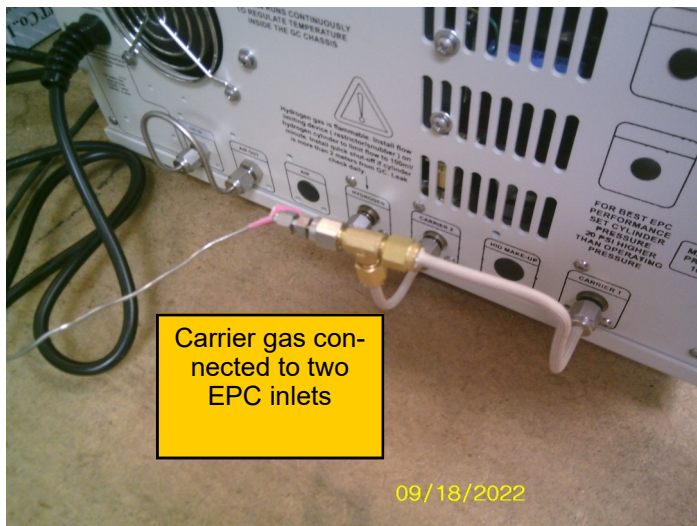

The air EPC has been removed in favor of adding the 2nd carrier gas EPC ( same cost ). The air EPC was not really necessary especially since the FID air flow never changed, and the built-in air compressor delivers a very steady pressure.

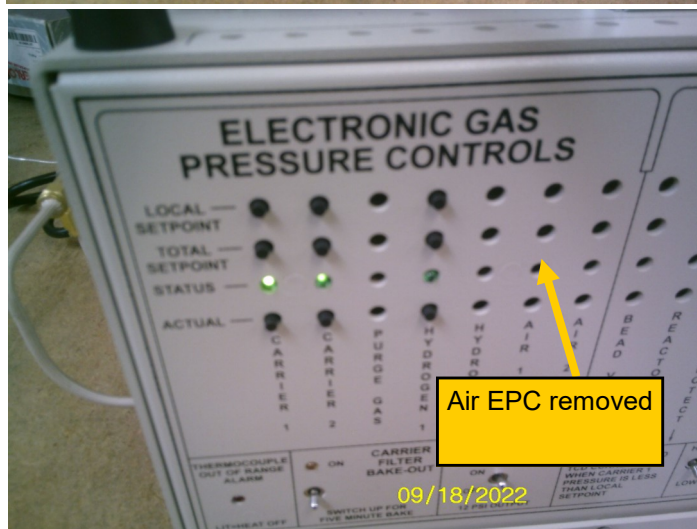

If required the air EPC can be added back for the cost of an EPC module.

The built-in air compressor is routed through a particle filter then then out through a bulkhead fitting on the left.

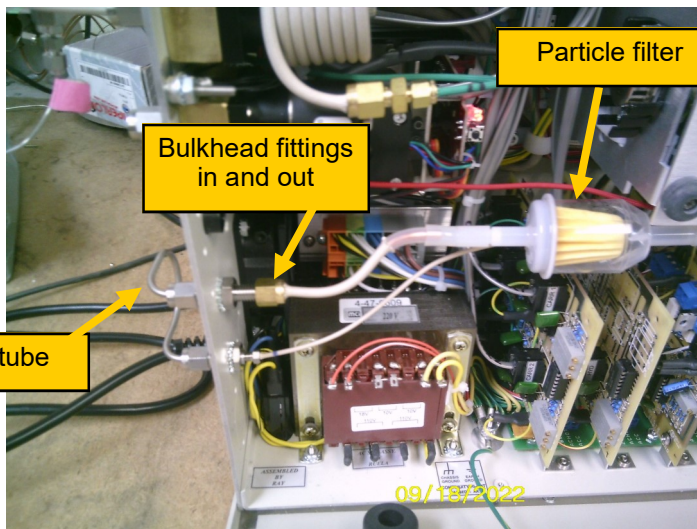

An empty piece of tube called a “jumper” then connects back to another bulkhead fitting, which then goes to the FID through a restrictor tube. The restrictor tube is made so 12 psi of air pressure results in a flow of 250ml/minute to the FID flame.

This allows the substitution of another air supply ( house air ) at 12psi if desired.

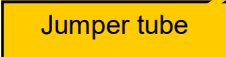



# Multiple Gas#5 GC configuration October 2022

These drawings show the plumbing configuration and the air supply for the FID

