

# VIALS & BOTTLES : Products Catalog

## SCREW and Crimp Caps

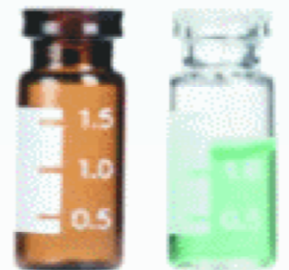

**CHROM**alytic +61(0)3 9762 2034  
**ECH**nology Pty Ltd

**Australian Distributors**  
Importers & Manufacturers  
[www.chromtech.net.au](http://www.chromtech.net.au)

Website NEW : [www.chromalytic.net.au](http://www.chromalytic.net.au) E-mail : [info@chromtech.net.au](mailto:info@chromtech.net.au) Tel: 03 9762 2034 . . . in AUSTRALIA

# VIAL and BOTTLE Products Catalog

## SCREW and Crimp Caps

USA & CANADA  
EUROPE & ASIA

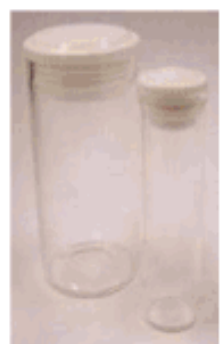
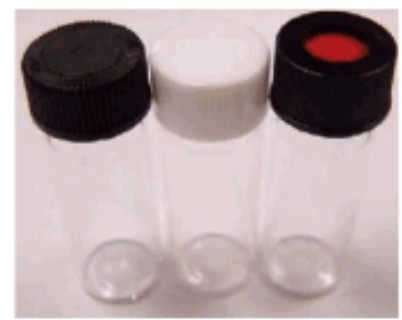

# C O N T E N T S

## TEST TUBES, AMPOULES & VIALS

PUVÁÖŠŠÁã•É[ ç^•Šã ç^á•Á•Á UY Áçãã|ÁÛÖŠÁ  
V@•^Á!|{ ç^ ÁÛç &^áã Á^!á[~!}^Á!ÁçFI áæ•Áçãããã Á•Áã ç^áã ÁÛ^á

CLEAR BOROSILICATE TEST TUBES (3ML,5ML,9ML,14ML,22ML,28ML,34ML,50ML)	P.4
CLEAR BOROSILICATE AMPOULES (1ML,2ML,5ML,10ML)	P.5
AMBER BOROSILICATE AMPOULES (1ML,2ML,5ML,10ML)	P.6
CLEAR BOROSILICATE SPECIMEN TUBES (4ML,18ML)	P.7
CLEAR BOROSILICATE VIALS, 13MM CRIMP (3ML)	P.8
CLEAR NEUTRAL BOROSILICATE VIALS, 20MM CRIMP (7ML,10ML,23ML,30ML)	P.9
AMBER BOROSILICATE VIALS, 20MM CRIMP (10ML,23ML)	P.10
CLEAR BOROSILICATE VIALS, 8MM SCREW (2ML)	P.11
CLEAR BOROSILICATE VIALS, 13MM SCREW (4ML)	P.12
CLEAR BOROSILICATE VIALS, 18MM SCREW (6ML, 11ML,12ML,15ML,17ML)	P.13
CLEAR BOROSILICATE VIALS, 24MM SCREW (20ML,36ML, 40ML, 50ML)	P.14
CLEAR BOROSILICATE VIALS, 22MM SCREW (21ML,25ML,36ML,50ML)	P.15
AMBER BOROSILICATE VIALS, 24MM SCREW (20ML)	P.16
CLEAR NEUTRAL BOROSILICATE VIALS, 13MM CRIMP (2ML 5ML,10ML)	P.17
CLEAR NEUTRAL BOROSILICATE VIALS, 20MM CRIMP (7ML,10ML,13ML,20ML,23ML,30ML)	P.18
AMBER NEUTRAL BOROSILICATE VIALS, 13MM CRIMP (2.5ML)	P.19
AMBER NEUTRAL BOROSILICATE VIALS, 20MM CRIMP (7ML, 10ML, 13ML,15ML,20ML)	P.20
CLEAR NEUTRAL BOROSILICATE VIALS, 18MM SCREW (5ML,7ML,7.5ML,13ML)	P.21
CLEAR NEUTRAL BOROSILICATE VIALS, 22MM SCREW (25ML,27ML)	P.22
AMBER NEUTRAL BOROSILICATE VIALS, 18MM SREW (7ML)	P.23
AMBER NEUTRAL BOROSILICATE VIALS, 20MM SCREW (20ML)	P.24
CLEAR BOROSILICATE TEST TUBES, 15MM SCREW (10ML)	P.25
AMBER AUTO SAMPLER CHOMOTOGRAPHY VIALS, 9MM SCREW FINSH (2ML)	P.26
CLEAR AUTO SAMPLER CHOMOTOGRAPHY VIALS, 8MM SCREW FINSH (2ML)	P.27



# C O N T E N T S

## MOULDED BOTTLES, GLASS DROPPERS, POLY CAPS, ALUMINIUM CRIMPS & RUBBER STOPPERS

AMBER TYPE 2 SULPHUR TREATED & WASHED MOULDED BOTTLES MOULDED BOTTLES, 20MM CRIMP FINISH (8ML, 10ML, 15ML, 20ML, 30ML, 50ML, 100ML)	P.28
AMBER TYPE 3, GLASS MOULDED ROUND BOTTLES, 20MM CRIMP FINISH (8ML, 10ML, 15ML, 20ML, 30ML, 50ML, 100ML)	P.29
CLEAR TYPE 1 GLASS BOROSILICATE MOULDED BOTTLE, 20MM CRIMP FINISH (7.5ML, 10ML, 15ML, 20ML, 30ML, 50ML, 100ML)	P.30
CLEAR TYPE 2 SULPHUR TREATED & WASHED MOULDED BOTTLES MOULDED BOTTLES, 20MM CRIMP FINISH (7ML, 8ML, 10ML, 15ML, 20ML, 30ML, 50ML, 100ML)	P.31
CLEAR TYPE 3 GLASS MOULDED ROUND BOTTLES, 20MM CRIMP FINISH (7ML, 8ML, 10ML, 15ML, 20ML, 30ML, 50ML, 100ML)	P.32
CLEAR TYPE 2 SULPHUR TREATED & WASHED MOULDED ANTIBIOTIC INJECTION BOTTLES, GB19.7MM CRIMP FINISH (5ML, 7ML, 7.5ML, 10ML, 15ML, 18ML, 20ML, 30ML, 32ML)	P.33
CLEAR TYPE 3 GLASS MOULDED ROUND ANTIBIOTIC INJECTION BOTTLE, GB19.7MM CRIMP FINISH (5ML, 7ML, 7.5ML, 10ML, 15ML, 18ML, 20ML, 30ML, 32ML)	P.34
AMBER TYPE 3 GLASS DROP DISPENSING BOTTLES, 18MM DIN SCREW FINISH (5ML, 10ML, 15ML, 20ML, 25ML, 30ML, 50ML, 100ML)	P.35
CLEAR TYPE 3 GLASS DROP DISPENSING BOTTLES, 18MM DIN SCREW FINISH (5ML, 10ML, 15ML, 20ML, 25ML, 30ML, 50ML, 100ML)	P.36
AMBER TYPE 3 GLASS PHARMA ROUND BOTTLES 24MM TAMPERTEL FINISH (50ML, 100ML, 200ML, 500ML)	P.37
AMBER TYPE 3 GLASS MOULDED ROUND SYRUP BOTTLES, 28MM PP SCREW FINISH (30ML, 45ML, 60ML, 100ML, 125ML)	P.38
CLEAR TYPE 3 GLASS MOULDED SYRUP BOTTLE, DIN PP 28MM FINISH (30ML, 60ML, 125ML)	P.39
AMBER TYPE 3 GLASS MOULDED BOSTON ROUND BOTTLES, 400/18, 20, 22MM SCREW FINISH (15ML, 30ML, 60ML, 120ML)	P.40
AMBER TYPE 3 GLASS MOULDED TABLET BOTTLES, 400/33, 38, 45MM FINISH (60ML, 75ML, 100ML, 120ML, 150ML, 200ML, 250ML)	P.41
AMBER TYPE 3 GLASS MOULDED SYRUP BOTTLES, PP 18, 20, 22MM SCREW FINISH (15ML, 30ML, 60ML, 120ML)	P.42
AMBER TYPE 3 GLASS MOULDED SYRUP BOTTLES 28MM PP FINISH (50ML, 75ML, 100ML, 150ML)	P.43
CLEAR TYPE 2 GLASS MOULDED INFUSION BOTTLES, ISO SFDA 32MM (50ML, 100ML)	P.44
CLEAR TYPE 3 GLASS MOULDED ESSENCE BOTTLE, GPI 400/18, 20MM FINISH (15ML, 20ML, 30ML, 60ML)	P.45
RUBBER BULB GLASS DROPPER ASSEMBLIES (ASSORTED SIZES)	P. 46
FINE MIST SPRAYERS & LOTION PUMPS (ASSORTED SIZES)	P.47
POLYPROPYLENE RING SEAL SCREW CAPS / POLYPROPYLENE PUSH IN CAPS (10MM, 18MM, 20MM, 22MM, 24MM, ¼", ½", 1")	P. 48
POLYPROPYLENE CAP WITH POLYETHYLENE DRIPULATOR CAPS (18MM)	P.49
POLYPROPYLENE TAMPER EVIDENT CHILD RESISTANT CAPS (24MM, 28MM)	P.50
ALUMINIUM CRIMP CLOSURES (13MM, 20MM) ASSORTED COLOURS	P.51
ALUMINIUM FLIP OFF CRIMP CLOSURES (13MM, 20MM) ASSORTED COLOURS	P.52
ALUMINIUM FLIP OFF CRIMP CLOSURES (13MM, 20MM) ASSORTED COLOURS	P.53
FREEZE DRY RUBBER STOPPERS (13MM, 20MM)	P. 54
INJECTABLE RUBBER STOPPERS (13MM, 20MM)	P.55
MANUAL HAND CRIMPER & DECAPPER (11MM, 13MM, 20MM)	P.56
TECHNICAL CERTIFICATION	P.57
TECHNICAL CERTIFICATION	P.58
TECHNICAL CERTIFICATION	P.59



AUSTRALIAN PHARMA CONTAINERS PTY LTD ABN 55 098 258 774

Unit 4, 33-35 Lower Gibbes Street, CHATSWOOD NSW 2067 \* PO Box 1385, NEUTRAL BAY NSW 2089

Ph: +61 2 9417 1322 Fax: +61 2 9417 0163 E-mail: [apc@pacific.net.au](mailto:apc@pacific.net.au)

 <p><b>HROMalytic</b> +61(0)3 9762 2034</p> <p><b>ECH</b>nology Pty Ltd</p>	<p><b>Australian Distributors</b>                  Importers &amp; Manufacturers  <a href="http://www.chromtech.net.au">www.chromtech.net.au</a></p>
<p><b>Website NEW : <a href="http://www.chromalytic.net.au">www.chromalytic.net.au</a> E-mail : <a href="mailto:info@chromtech.net.au">info@chromtech.net.au</a> Tel: 03 9762 2034 . . . in AUSTRALIA</b></p>	

# Clear Borosilicate Glass Test Tubes

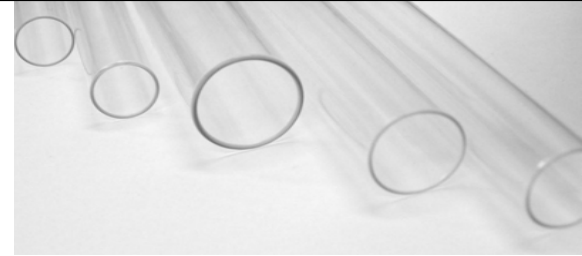
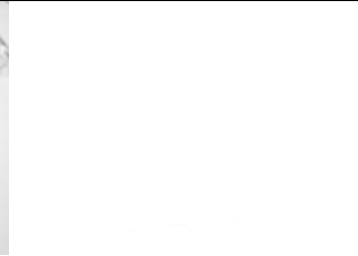
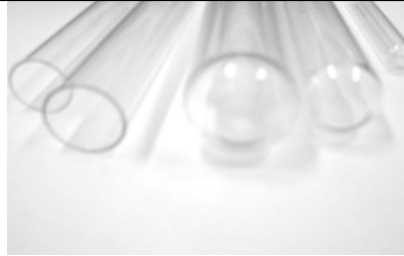
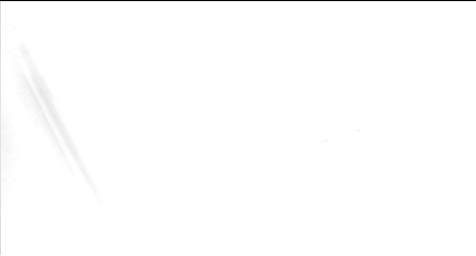

PRODUCT CODE	CAPACITY	BRIMFUL CAPACITY	LENGTH	WIDTH	WALL THICKNESS	RIM	CARTON QUANTITY
CT10B	3ml	4.50ml	75mm	10.0mm	0.6mm ± 0.05	RIMLESS	3,000
CT12B	5ml	6.90ml	75mm	12.0mm	0.6mm ± 0.05	RIMLESS	1,000
CT13B	9ml	11.00ml	100mm	13.0mm	0.6mm ± 0.05	RIMLESS	1,000
CT16B	14ml	16.6ml	100mm	16.0mm	0.7mm ± 0.05	RIMLESS	1,000
CT166B	22ml	25.00ml	150mm	13.8mm	0.7mm ± 0.05	RIMLESS	1,000
CT18B	28ml	30.00ml	150mm	18.0mm	0.7mm ± 0.05	RIMLESS	1,000
CT20B	34ml	39.00ml	150mm	20.0mm	0.8mm ± 0.05	RIMLESS	1,000
CT24B	50ml	54.00ml	150mm	24.0mm	1.0mm ± 0.05	RIMLESS	1,000
CT24B1	50ml	54.00ml	150mm	24.0mm	1.0mm ± 0.05	RIMMED	1,000

PRODUCT CODE	DIMENSIONS OF INNER CARTON	DIMENSIONS OF OUTER CARTON	UNITS PER TRAY	INDIVIDUAL WEIGHT
CT10B	265 x 80 x 90	390 x 290 x 270	250	3.06g ~ 3.69g
CT12B	310 x 105 x 115	330 x 250 x 180	250	3.64g ~ 4.03g
CT13B	350 x 105 x 115	360 x 250 x 240	250	5.53g ~ 6.06g
CT16B	420 x 105 x 145	410 x 310 x 230	250	7.83g ~ 8.60g
CT166B	420 x 155 x 145	440 x 320 x 340	250	11.56g ~ 12.63g
CT18B	470 x 455 x 160	480 x 340 x 340	250	15.48g ~ 16.14g
CT20B	520 x 155 x 180	555 x 345 x 380	250	17.41g ~ 18.01g
CT24B	350 x 155 x 150	500 x 260 x 500	100	31.24g ~ 31.83g
CT24B1	350 x 155 x 150	500 x 260 x 500	100	32.45g ~ 33.04g

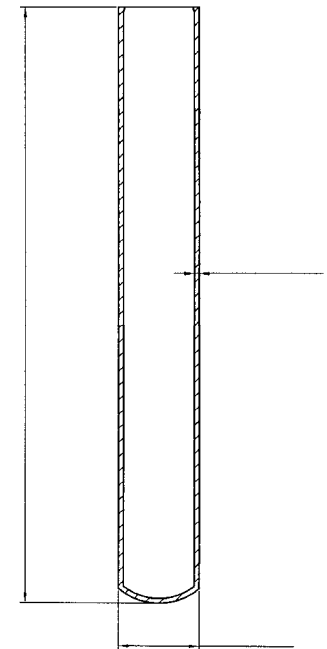



**HROMalytic** +61(0)3 9762 2034  
**ECH**nology Pty Ltd

**Australian Distributors**  
 Importers & Manufacturers  
[www.chromtech.net.au](http://www.chromtech.net.au)

**Website NEW : [www.chromalytic.net.au](http://www.chromalytic.net.au) E-mail : [info@chromtech.net.au](mailto:info@chromtech.net.au) Tel: 03 9762 2034 . . . in AUSTRALIA**

# Clear Borosilicate Glass Ampoules

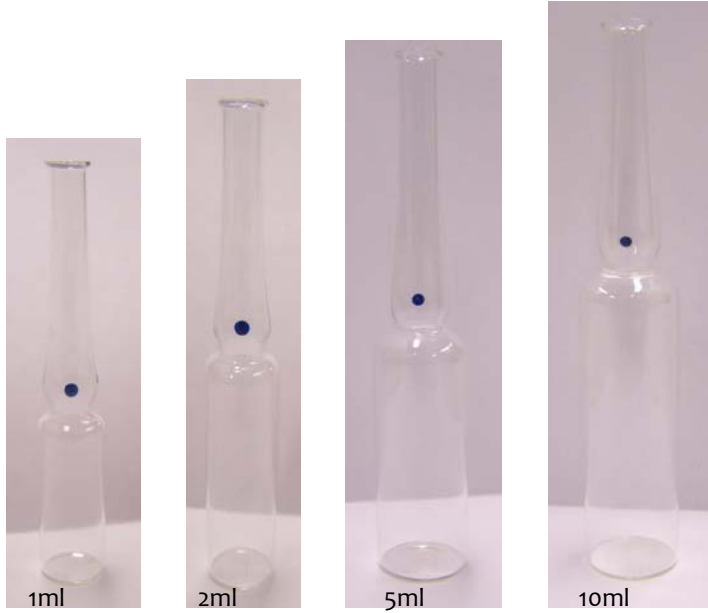
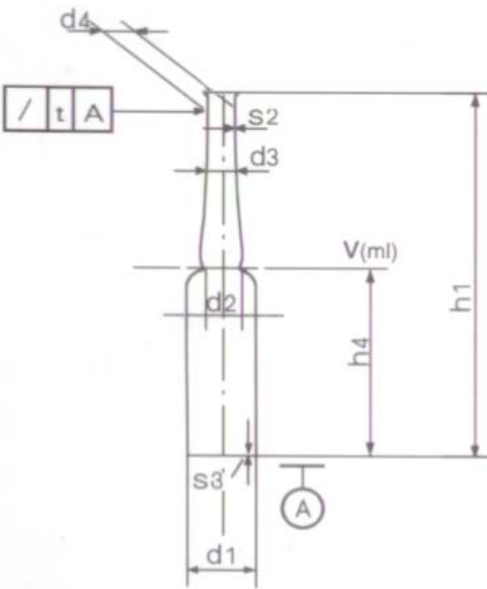

	ml	d1	d2	d3	d4	h1	h4	s2	s3	V (ml)	TRAY QUANTITY	CARTON QUANTITY 5
<b>PRODUCT CODE</b>												
CT02SCAMP	2ml	11.50	7.00	8.50	5.50	70.00	36.50	0.20	0.20	2.90	455	7,280
CT05SCAMP	5ml	16.00	8.20	10.00	6.00	87.00	43.00	0.20	0.30	6.80	480	7,680
CT10SCAMP	10ml	18.40	8.80	11.00	6.80	102.00	58.50	0.25	0.30	12.30	272	2,176

# Amber Borosilicate Glass Ampoules

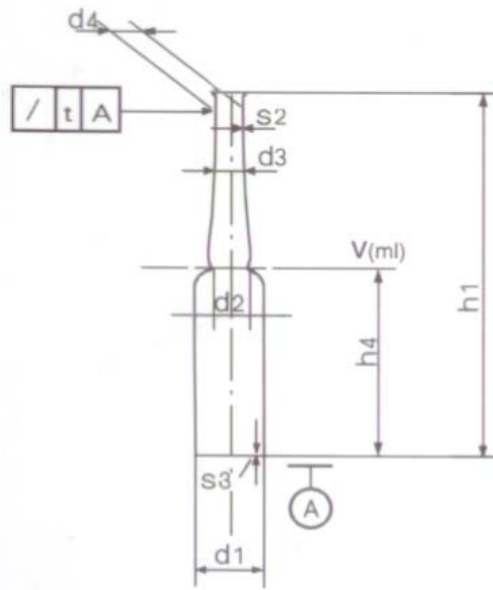

	ml	d1	d2	d3	d4	h1	h4	s2	s3	V (ml)	TRAY QUANTITY	CARTON QUANTITY
<b>PRODUCT CODE</b>												
CT01SAAMP	1ml	10.00	6.30	7.80	5.00	60.00	25.00	0.20	0.20	1.50	348	5,568
CT02SAAMP	2ml	11.50	7.00	8.50	5.50	70.00	36.50	0.20	0.20	2.90	455	7,280
CT05SAAMP	5ml	16.00	8.20	10.00	6.00	87.00	43.00	0.20	0.30	6.80	480	7,680
CT10SAAMP	10ml	18.40	8.80	11.00	6.80	102.00	58.50	0.25	0.30	12.30	272	2,176



**HROMalytic** +61(0)3 9762 2034

**ECH**nology Pty Ltd

**Australian Distributors**  
 Importers & Manufacturers  
[www.chromtech.net.au](http://www.chromtech.net.au)

**Website NEW : [www.chromalytic.net.au](http://www.chromalytic.net.au) E-mail : [info@chromtech.net.au](mailto:info@chromtech.net.au) Tel: 03 9762 2034 . . . in AUSTRALIA**

# Clear Borosilicate Type 1 Specimen Tubes

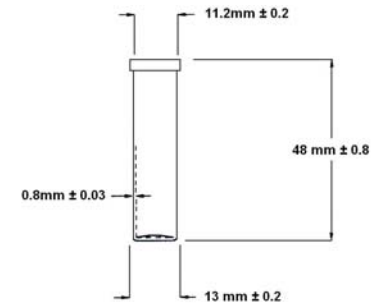
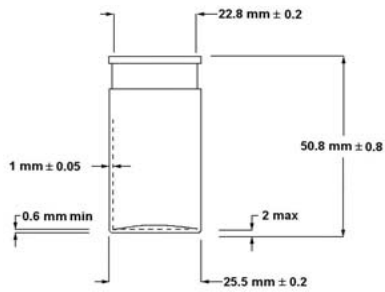

PRODUCT CODE								CARTON QUANTITY
CT501060B	18ml	16.10	20.10	11.36g ~ 11.98g	22mm PUSH-IN	50.80	22.80	1,000
CT501011B	4ml	4.00	4.50	3.76g ~ 4.34g	11mm PUSH-IN	48.00	11.20	3,952



**HROMalytic** +61(0)3 9762 2034

**ECH**nology Pty Ltd

**Australian Distributors**  
 Importers & Manufacturers  
[www.chromtech.net.au](http://www.chromtech.net.au)

**Website NEW : [www.chromalytic.net.au](http://www.chromalytic.net.au) E-mail : [info@chromtech.net.au](mailto:info@chromtech.net.au) Tel: 03 9762 2034 . . . in AUSTRALIA**



# Clear Borosilicate Type 1 glass vials, 13mm Crimp Finish

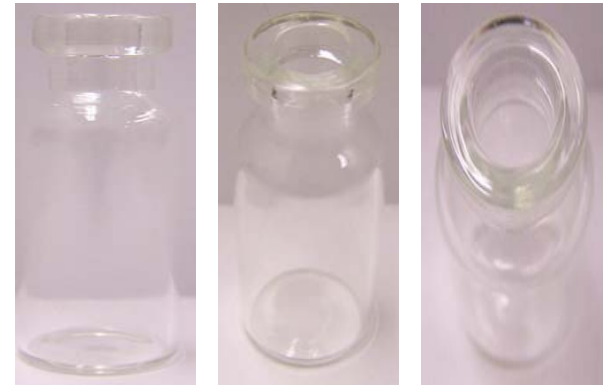
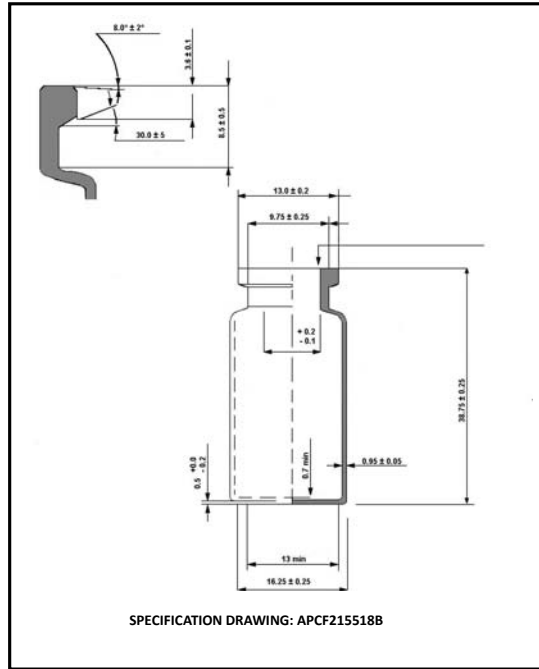

PRODUCT CODE	3ml	4.00	4.80	5.09g ~ 5.65g	13mm	38.75	16.25	CARTON QUANTITY
CTF215518B								3,060

ÔVÛÖË XËHVËÏ ÔHÏ P  
 ÔVÛÖË XËHVËÏ ÔHÏ P

Q | Ô | ^ | a | ^ | d | a | B | & | Q | c | Ô | | : | • | a | B | a | ^ | ^ | Ô | | a | • | A | k | a | F | H | { | Ô | i | a | ] | Á | V | ] | Ê | Ì | F | È | | a |



# Amber Borosilicate Type 1 glass vials, 20mm Crimp Finish



PRODUCT CODE								CARTON QUANTITY
CTSA-13V-20T	10ml (13ml)	12.00	13.80	13.16g ~ 13.85g	20mm	50.00	23.75	1,512



**CHROMalytic** +61(0)3 9762 2034  
**ECHnology** Pty Ltd

**Australian Distributors**  
 Importers & Manufacturers  
[www.chromtech.net.au](http://www.chromtech.net.au)

Website NEW : [www.chromalytic.net.au](http://www.chromalytic.net.au) E-mail : [info@chromtech.net.au](mailto:info@chromtech.net.au) Tel: 03 9762 2034 . . . in AUSTRALIA

# Clear Borosilicate Type 1 glass vials, 8mm Screw Finish



CAP TO SUIT - CT105.RSP00

\* CAP ALSO AVILABLE WITH WADDING ON REQUEST.



PRODUCT CODE							CARTON QUANTITY	
CT502219B	2ml	1.50	1.90	2.34g ~ 2.85g	8mm	32.00	11.50	4,000

# Clear Borosilicate Type 1 glass vials, 13mm Screw Finish



## CAPS TO SUIT

- 13mm Black polypropylene ring seal screw cap with silicon septa insert
- 13mm White polypropylene ring seal screw cap with PP septa insert
- 13mm Black Two hole cap with PTFE septa insert

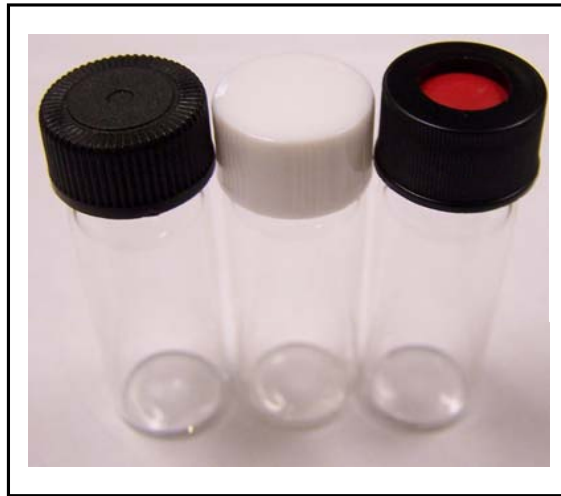

PRODUCT CODE							CARTON QUANTITY	
CT502214B	4ml	4.00	4.80	4.75g ~ 5.26g	13mm	45.00	14.75	3,600



**Australian Distributors**  
 Importers & Manufacturers  
[www.chromtech.net.au](http://www.chromtech.net.au)

Website NEW : [www.chromalytic.net.au](http://www.chromalytic.net.au) E-mail : [info@chromtech.net.au](mailto:info@chromtech.net.au) Tel: 03 9762 2034 . . . in AUSTRALIA

# Clear Borosilicate Type 1 glass vials, 18mm Screw Finish



CAPS TO SUIT – CT18R



CT502015B



CT502108B



CT1218SCR



PRODUCT CODE								CARTON QUANTITY
CT502015B	6ml	6.00	7.50	8.00g ~ 8.78g	18mm	44.40	19.00	2,496
CT502108B	11ml	11.80	13.80	10.67g ~ 11.40g	18mm	55.00	22.00	1,980
CT1218SCR	12ml	11.00	13.00	10.91g ~ 11.64g	18mm	60.00	20.00	1,584



**HROMalytic** +61(0)3 9762 2034  
**ECHnology** Pty Ltd

**Australian Distributors**  
 Importers & Manufacturers  
[www.chromtech.net.au](http://www.chromtech.net.au)

**Website NEW : [www.chromalytic.net.au](http://www.chromalytic.net.au) E-mail : [info@chromtech.net.au](mailto:info@chromtech.net.au) Tel: 03 9762 2034 . . . in AUSTRALIA**

# Clear Borosilicate Type 1 glass vials, 24mm Screw Finish

CT502105B  
20ml



APC40MA  
40ml



CT502215B  
36ml



APC502050B  
50ml



APC24PLP000 - 24mm x 400 White polypropylene caps with wadding



APC24S.RSP000 - 24mm x 400mm White polypropylene ring seal caps



APCP24B - 24mm X 400mm Black polypropylene ring seal caps



CTP24B - 1-24mm x 400 Black polypropylene caps with wadding



PRODUCT CODE		CARTON QUANTITY						
CT502105B	20ml	20.80	26.30	17.25g ~ 17.94g	24mm	55.00	29.00	850
CT502215B	36ml	36.00	39.00	24.02g ~ 25.10g	24mm	81.00	29.00	850
CT40MA	40ml	38.00	42.50	24.03g ~ 23.34g	24mm	95.00	23.50	
CT 502050B	50ml	47.60	51.40	32.69g ~ 33.77g	24mm	100.00	30.00	480

**HROMalytic** +61(0)3 9762 2034  
**ECHnology** Pty Ltd

**Australian Distributors**  
Importers & Manufacturers  
[www.chromtech.net.au](http://www.chromtech.net.au)

Website NEW : [www.chromalytic.net.au](http://www.chromalytic.net.au) E-mail : [info@chromtech.net.au](mailto:info@chromtech.net.au) Tel: 03 9762 2034 . . . in AUSTRALIA

# Clear Borosilicate Type 1 glass vials, 22mm Screw Finish



CT52039B



CT502210B

**CAP TO SUIT**  
CT22RSP000 – 22mm White polypropylene ring seal cap



PRODUCT CODE	Volume	Weight	Height	Diameter	Length	Weight	Quantity	CARTON QUANTITY
CT502039B	21ml	20.00	22.00	15.52g ~ 16.31g	22mm	57.20	27.00	990
CT502210B	25ml	27.40	31.20	20.42g ~ 21.50g	22mm	76.00	27.00	792



**HROMalytic** +61(0)3 9762 2034  
**ECHnology** Pty Ltd

**Australian Distributors**  
Importers & Manufacturers  
[www.chromtech.net.au](http://www.chromtech.net.au)

**Website NEW : [www.chromalytic.net.au](http://www.chromalytic.net.au) E-mail : [info@chromtech.net.au](mailto:info@chromtech.net.au) Tel: 03 9762 2034 . . . in AUSTRALIA**



# Amber Borosilicate Type 1 glass vials, 24mm Screw Finish



PRODUCT CODE							CARTON QUANTITY
CT502155A	20ml	21.80	35.20	17.98g ~ 18.67g	24mm	55.00	29.00
							850



**HRMalytic** +61(0)3 9762 2034  
**ECHnology** Pty Ltd

**Australian Distributors**  
 Importers & Manufacturers  
[www.chromtech.net.au](http://www.chromtech.net.au)

**Website NEW : [www.chromalytic.net.au](http://www.chromalytic.net.au) E-mail : [info@chromtech.net.au](mailto:info@chromtech.net.au) Tel: 03 9762 2034 . . . in AUSTRALIA**

# Clear Neutral Borosilicate Type 1 glass vials, 13mm Crimp Finish



PRODUCT CODE								CARTON QUANTITY
CT461505S	2ml	3.00	3.50	3.50g ~ 3.62g	13mm	32.00	13.10	3,710
CTB02140S	2ml	3.50	4.50	4.40g ~ 4.87g	13mm	37.50	13.10	3,680
CT411922	5ml				13mm	38.50	13.10	
CTB02171S	10ml	10.00	10.80	7.57g ~ 8.05g	13mm	45.00	13.10	1,980
CTB02178S	10ml	13.00	14.00	9.74g ~ 10.16g	13mm	50.00	13.10	1,320

**HROM**alytic +61(0)3 9762 2034  
**ECH**nology Pty Ltd

**Australian Distributors**  
 Importers & Manufacturers  
[www.chromtech.net.au](http://www.chromtech.net.au)

Website NEW : [www.chromalytic.net.au](http://www.chromalytic.net.au) E-mail : [info@chromtech.net.au](mailto:info@chromtech.net.au) Tel: 03 9762 2034 . . . in AUSTRALIA

# Clear Neutral Borosilicate Type 1 glass vials, 20mm Crimp Finish

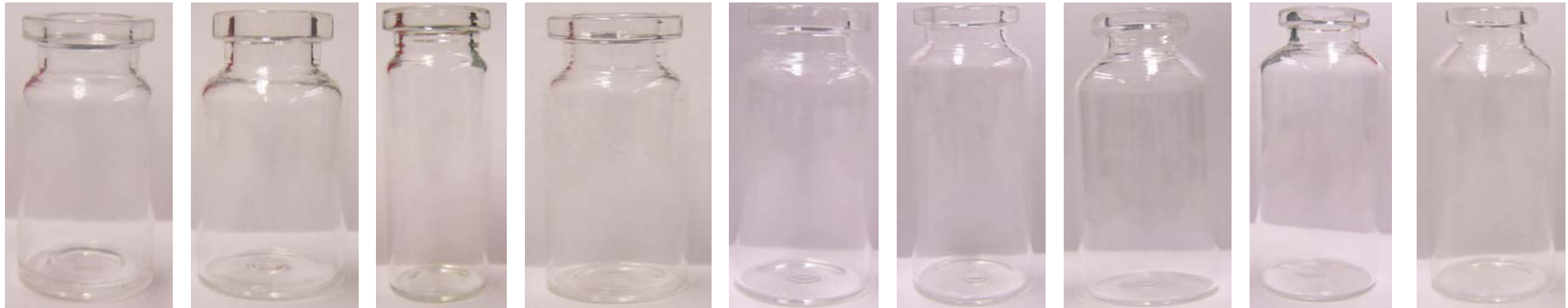

CT505243S      CT400610S      CT505910S      CTB02168S      CT505258S      CT415626S      CTB02205S      CTB02213S      CT505230S



PRODUCT CODE								CARTON QUANTITY
CT505243S	7ml	7.80	8.90	7.03g ~ 7.58g	20mm	37.50	22.00	2,100
CT400610S	10ml	10.80	13.00	9.05g ~ 9.63g	20mm	40.50	25.50	1,740
CT505910S	10ml	10.80	11.20	9.87g ~ 10.50g	20mm	56.50	20.50	1,850
CTB02168S	10ml	10.00	11.60	8.41g ~ 8.95g	20mm	45.00	22.00	1,980



**HROMalytic** +61(0)3 9762 2034  
**ECH**nology Pty Ltd

**Australian Distributors**  
 Importers & Manufacturers  
[www.chromtech.net.au](http://www.chromtech.net.au)

**Website NEW : [www.chromalytic.net.au](http://www.chromalytic.net.au) E-mail : [info@chromtech.net.au](mailto:info@chromtech.net.au) Tel: 03 9762 2034 . . . in AUSTRALIA**

# Amber Neutral Borosilicate Type 1 glass vials, 13mm Crimp Finish



CTV12025S



APC25135A



PRODUCT CODE	2.5ml	3.00	3.50	3.70g ~ 4.22g	13mm	35.00	14.75	CARTON QUANTITY
CTV12025S	2.5ml	3.00	3.50	3.70g ~ 4.22g	13mm	35.00	14.75	4,250
CT25135A	2.5ml	2.50	3.00	3.97g ~ 4.49g	13mm	32.00	15.00	3,710



**HROMalytic** +61(0)3 9762 2034



**ECHnology** Pty Ltd

**Australian Distributors**  
 Importers & Manufacturers  
[www.chromtech.net.au](http://www.chromtech.net.au)

**Website NEW : [www.chromalytic.net.au](http://www.chromalytic.net.au) E-mail : [info@chromtech.net.au](mailto:info@chromtech.net.au) Tel: 03 9762 2034 . . . in AUSTRALIA**



# Clear Neutral Borosilicate Type 1 glass vials, 18mm Screw Finish



CTB02161S



CTDN2221S



APCDN2223S



CTDN2224S



CAP TO SUIT – APC18R



PRODUCT CODE								CARTON QUANTITY
CTB02161S	7ml	6.50	9.30	7.05g ~ 7.57g	18mm	39.00	22.00	1,980
CTDN2221S	13ml	6.00	10.80	10.62g ~ 11.21g	18 DIN	60.00	22.00	1,584
CTDN2223S	5ml	5.03	6.08	8.03g ~ 8.62g	18 DIN	31.00	20.50	2,960
CTDN2224S	7.5ml	6.60	8.80	7.49g ~ 7.99g	18 DIN	40.00	27.00	1,980

# Clear Neutral Borosilicate Type 1 glass vials, 22mm Screw Finish



CT02210S



CTB02053S



CTDN2225S



CAP TO SUIT - CT502210S, CTB02053S

CT22RSP000 - 22mm White polypropylene ring seal cap

\* Cap is available in Black on request.



PRODUCT CODE								CARTON QUANTITY	
CT502210S	25ml	29.00	32.00	18.86g ~ 19.65g	22mm	76.00	27.00	990	
CTB02053S	25ml	29.00	32.00	18.41g ~ 18.80g	22mm	76.00	27.00	792	
CTDN2225S	27ml	28.00	31.00	19.25g ~ 19.98g	22mm	76.00	27.00	976	



**HROMalytic** +61(0)3 9762 2034

**ECHnology** Pty Ltd

**Australian Distributors**  
 Importers & Manufacturers  
[www.chromtech.net.au](http://www.chromtech.net.au)

**Website NEW : [www.chromalytic.net.au](http://www.chromalytic.net.au) E-mail : [info@chromtech.net.au](mailto:info@chromtech.net.au) Tel: 03 9762 2034 . . . in AUSTRALIA**

# Amber Neutral Borosilicate Type 1 glass vials, 18mm Screw Finish



CTB02158S



CAP TO SUIT – CT18R



PRODUCT CODE							CARTON QUANTITY	
CTB02158S	7ml	7.00	8.80	7.24g ~ 7.71g	18mm	39.00	21.50	1,980

**HROM**alytic +61(0)3 9762 2034  
**ECH**nology Pty Ltd

**Australian Distributors**  
 Importers & Manufacturers  
[www.chromtech.net.au](http://www.chromtech.net.au)

Website NEW : [www.chromalytic.net.au](http://www.chromalytic.net.au) E-mail : [info@chromtech.net.au](mailto:info@chromtech.net.au) Tel: 03 9762 2034 . . . in AUSTRALIA



# Amber Neutral Borosilicate Type 1 glass vials, 20mm Screw Finish



CAPS TO SUIT -

CT517805C

\* Cap is available in Black on request.



PRODUCT CODE							CARTON QUANTITY	
CT502282TPTS	20ml	24.00	27.00	17.76g ~ 18.45g	20mm	70.00	26.60	1,080

**HROM**alytic +61(0)3 9762 2034  
**ECH**nology Pty Ltd

**Australian Distributors**  
 Importers & Manufacturers  
[www.chromtech.net.au](http://www.chromtech.net.au)

Website NEW : [www.chromalytic.net.au](http://www.chromalytic.net.au) E-mail : [info@chromtech.net.au](mailto:info@chromtech.net.au) Tel: 03 9762 2034 . . . in AUSTRALIA

# Clear Borosilicate Test Tubes with Screw Finish

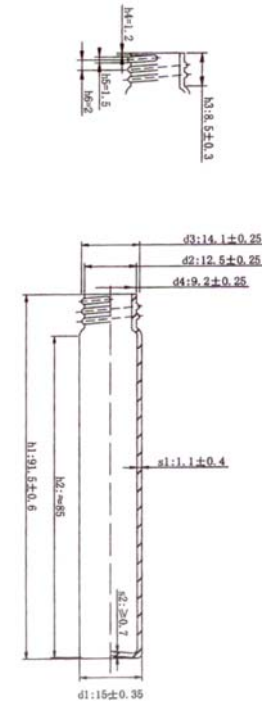

PRODUCT CODE							CARTON QUANTITY
CT502010B	10ml	10.00	11.00	11.24g	15mm	96.70	14.15



**Australian Distributors**  
 Importers & Manufacturers  
[www.chromtech.net.au](http://www.chromtech.net.au)

Website NEW : [www.chromalytic.net.au](http://www.chromalytic.net.au) E-mail : [info@chromtech.net.au](mailto:info@chromtech.net.au) Tel: 03 9762 2034 . . . in AUSTRALIA

# Amber Borosilicate type 1 glass, 9mm Screw finish



PRODUCT CODE

CARTON QUANTITY

~~ŠÓUX€€C0#€€Ě \~~

2ml

1.50

2.00

9mm

32.00

8.50

~~ŠÓUXF€C0ÙÙ#€€Ě \ ÁŮ^áÁŮVØØ @^Á qax }^Á^] €€ÉÓ|^Á&^, Á€q Á ã@Q|^ÉĚ |ÁQ |ÁĚ G Á&^, ÁĚ ] Á€q~~





# Amber Moulded Injection Vials – ISO/SFDA 20mm crimp finish USP Type III

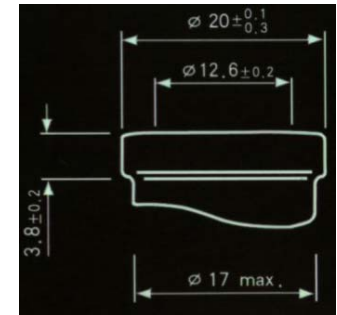

PRODUCT CODE								CARTON QUANTITY
CTPY8A	8ml	8.00	10.00	16.00	20mm	46.8	23.00	936
CTPY10A	10ml	10.00	15.00	21.00	20mm	53.50	25.40	768
CT15A	15ml	15.00	17.00	22.00	20mm	58.80	26.50	660
CTPY20A	20ml	20.00	26.00	29.00	20mm	58.00	32.00	480
CTPY30A	30ml	30.00	38.00	35.00	20mm	62.80	36.00	276
CTPY50A	50ml	50.00	60.00	50.00	20mm	73.00	42.50	336
CTPY100A	100ml	100.00	119.00	89.00	20mm	94.50	51.60	198



**CHROMalytic** +61(0)3 9762 2034  
**ECHnology** Pty Ltd

**Australian Distributors**  
 Importers & Manufacturers  
[www.chromtech.net.au](http://www.chromtech.net.au)

**Website NEW : [www.chromalytic.net.au](http://www.chromalytic.net.au) E-mail : [info@chromtech.net.au](mailto:info@chromtech.net.au) Tel: 03 9762 2034 . . . in AUSTRALIA**

# Clear Borosilicate Glass USP Type 1



PRODUCT CODE								CARTON QUANTITY
CT220075C	7.5ml	7.50	8.50	14.00	20mm	36.20	24.60	
CT220102C	10ml	10.00	13.00	20.00	20mm	56.10	24.60	
CT220101C	10ml	10.00	15.00	21.00	ISO/SFDA	53.50	25.40	
CT220201C	20ml	20.00	26.00	29.00	ISO/SFDA	58.00	32.00	
CT220301C	30ml	30.00	38.00	35.00	ISO/SFDA	62.80	36.00	276
CT220302C	30ml	30.00	37.00	38.00	20mm	26.50	27.80	276
CT220504C	50ml	50.00	68.00	60.00	ISO 32	68.00	46.00	336
CT220501	50ml	50.00	60.00	50.00	ISO/SFDA	73.00	42.50	336
CT221001C	100ml	100.00	119.00	89.00	ISO/SFDA	94.50	51.60	198
CT221004C	100ml	100.00	128.00	100.0	ISO 32	104.00	49.00	198



**HROMalytic** +61(0)3 9762 2034  
**ECHnology** Pty Ltd

**Australian Distributors**  
 Importers & Manufacturers  
[www.chromtech.net.au](http://www.chromtech.net.au)

**Website NEW : [www.chromalytic.net.au](http://www.chromalytic.net.au) E-mail : [info@chromtech.net.au](mailto:info@chromtech.net.au) Tel: 03 9762 2034 . . . in AUSTRALIA**

# Clear Moulded Injection Vials – ISO/SFDA 20mm crimp finish USP Type II – Sulphur Treated & Washed

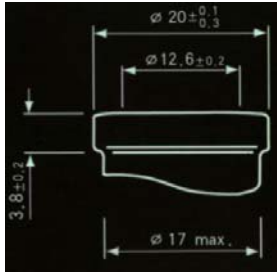

PRODUCT CODE								CARTON QUANTITY
CTPY7C -W	7ml	7.00	9.00	13.00	20mm	40.80	22.10	
CTPY8C -W	8ml	8.00	10.00	16.00	20mm	46.80	23.00	
CTPY10C -W	10ml	10.00	15.00	21.00	20mm	53.50	25.40	
CTPY15C -W	15ml	15.00	17.00	24.00	20mm	58.80	26.50	
CTPY20C -W	20ml	20.00	26.00	29.00	20mm	58.00	32.00	480
CTPY30C -W	30ml	30.00	38.00	35.00	20mm	62.80	36.00	276
CTPY50C-W	50ml	50.00	60.00	50.00	20mm	73.00	42.50	336
CTPY100C -W	100ml	100.00	119.00	89.00	20mm	94.50	51.60	198

**HROMalytic** +61(0)3 9762 2034  
**ECHnology** Pty Ltd

**Australian Distributors**  
 Importers & Manufacturers  
[www.chromtech.net.au](http://www.chromtech.net.au)

Website NEW : [www.chromalytic.net.au](http://www.chromalytic.net.au) E-mail : [info@chromtech.net.au](mailto:info@chromtech.net.au) Tel: 03 9762 2034 . . . in AUSTRALIA



# Clear Moulded Injection Vials – ISO/SFDA 20mm crimp finish USP Type III

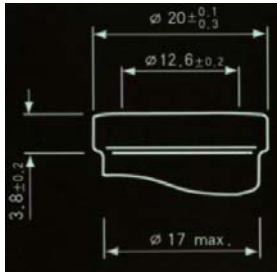

PRODUCT CODE							CARTON QUANTITY	
CTPY7C	7ml	7.00	9.00	13.00	20mm	40.80	22.10	
CTPY8C	8ml	8.00	10.00	16.00	20mm	46.80	23.00	
CTPY10C	10ml	10.00	15.00	21.00	20mm	53.50	25.40	
CTPY15C	15ml	15.00	17.00	24.00	20mm	58.80	26.50	
CTPY20C	20ml	20.00	26.00	29.00	20mm	58.00	32.00	480
CTPY30C	30ml	30.00	38.00	35.00	20mm	62.80	36.00	276
CTPY50C	50ml	50.00	60.00	50.00	20mm	73.00	42.50	336
CTPY100C	100ml	100.00	119.00	89.00	20mm	94.50	51.60	198

**HROMalytic** +61(0)3 9762 2034  
**ECH**nology Pty Ltd  
 Website NEW : [www.chromalytic.net.au](http://www.chromalytic.net.au) E-mail : [info@chromtech.net.au](mailto:info@chromtech.net.au) Tel: 03 9762 2034 . . . in AUSTRALIA

**Australian Distributors**  
 Importers & Manufacturers  
[www.chromtech.net.au](http://www.chromtech.net.au)

## Clear Moulded Injection Vials for Antibiotics Ring Finish GB19.7mm, USP Type II – Sulphur Treated & Washed



PRODUCT CODE								CARTON QUANTITY
CT120052C -W	5ml	5.00	7.30	12.90	GB/B	38.70	22.00	
CT120053C -W	7ml	7.00	9.00	13.50	GB/B	38.70	29.50	
CT120122C -W	12ml	12.00	16.00	21.00	GB/B	56.80	27.00	
CT120075C -W	7.5ml	7.50	8.50	14.00	20mm	63.20	24.60	
CT120103C -W	10ml	10.00	13.50	20.00	20mm	51.10	24.60	
CT120303C -W	30ml	30.00	37.00	38.00	20mm	61.50	37.80	
CT120323C -W	32ml	32.00	34.20	32.00	GB/B	66.00	33.00	
CT120108C -W	10ml	10.00	12.00	15.00	19.5mm	46.50	22.00	
CT120158C -W	15ml	15.00	17.00	21.00	19.5mm	45.50	29.50	
CT120208C -W	20ml	20.00	23.00	28.50	19.5mm	60.00	31.00	
CT120109C -W	10ml	10.00	15.00	19.40	ISO 20	55.00	23.80	
CT120155C -W	15ml	15.00	17.00	21.00	ISO 20	57.00	26.00	
CT120185C -W	18ml	18.00	21.00	26.90	ISO 20	57.00	30.00	

**HROMalytic** +61(0)3 9762 2034  
**ECHnology** Pty Ltd

**Australian Distributors**  
 Importers & Manufacturers  
[www.chromtech.net.au](http://www.chromtech.net.au)

Website NEW : [www.chromalytic.net.au](http://www.chromalytic.net.au) E-mail : [info@chromtech.net.au](mailto:info@chromtech.net.au) Tel: 03 9762 2034 . . . in AUSTRALIA

## Clear Moulded Injection Vials for Antibiotics Ring Finish GB19.7mm, USP Type III



PRODUCT CODE							CARTON QUANTITY
CT120052C	5ml	5.00	7.30	12.90	GB/B	38.70	22.00
CT120053C	7ml	7.00	9.00	13.50	GB/B	38.70	29.50
CT120122C	12ml	12.00	16.00	21.00	GB/B	56.80	27.00
CT120075C	7.5ml	7.50	8.50	14.00	20mm	63.20	24.60
CT120103C	10ml	10.00	13.50	20.00	20mm	51.10	24.60
CT120303C	30ml	30.00	37.00	38.00	20mm	61.50	37.80
CT120323C	32ml	32.00	34.20	32.00	GB/B	66.00	33.00
CT120108C	10ml	10.00	12.00	15.00	19.5mm	46.50	22.00
CT120158C	15ml	15.00	17.00	21.00	19.5mm	45.50	29.50
CT120208C	20ml	20.00	23.00	28.50	19.5mm	60.00	31.00
CT120109C	10ml	10.00	15.00	19.40	ISO 20	55.00	23.80
CT120155C	15ml	15.00	17.00	21.00	ISO 20	57.00	26.00
CT120185C	18ml	18.00	21.00	26.90	ISO 20	57.00	30.00

**HR**OMalytic +61(0)3 9762 2034  
**ECH**nology Pty Ltd

**Australian Distributors**  
 Importers & Manufacturers  
[www.chromtech.net.au](http://www.chromtech.net.au)

Website NEW : [www.chromalytic.net.au](http://www.chromalytic.net.au) E-mail : [info@chromtech.net.au](mailto:info@chromtech.net.au) Tel: 03 9762 2034 . . . in AUSTRALIA

# Amber Moulded Drop Dispensing Bottles – DIN 18mm



**CAPS TO SUIT (From Left to Right)**

**CT18WTPE** – 18mm White polypropylene ring seal screw, tamper proof tamper evident cap

**CT18BTPE** – 18mm Black polypropylene ring seal screw, tamper proof tamper evident cap

**CT18WTE** – 18mm Black polypropylene ring seal tamper evident cap

**CT18BTE** – 18mm White polypropylene ring seal tamper evident cap

**CT18 -WT** – 18mm White T/E poly propylene cap with dripolator inset

\* Polyethylene Dripolator plug is included with cap. (High Flow or regular flow.



PRODUCT CODE	ml	g	mm	CARTON QUANTITY				
CTDD5A	5ml	5.00	6.70	22.00	DIN 18	50.20	22.00	765
CTDD10A	10ml	10.00	12.50	27.50	DIN 18	58.00	24.80	768
CTDD15A	15ml	15.00	20.00	35.00	DIN 18	65.00	28.50	420
CTDD20A	20ml	20.00	22.50	35.00	DIN 18	71.50	28.70	420
CTDD25A	25ml	25.00	27.50	37.00	DIN 18	75.60	31.00	390
CTDD30A	30ml	30.00	35.00	48.00	DIN 18	78.80	33.00	345
CTDD50A	50ml	50.00	57.00	55.00	DIN 18	92.20	37.50	264
CTDD100A	100ml	100.00	105.00	88.00	DIN 18	112.00	44.50	140



**HROMalytic** +61(0)3 9762 2034  
**ECHnology** Pty Ltd

**Australian Distributors**  
 Importers & Manufacturers  
[www.chromtech.net.au](http://www.chromtech.net.au)

**Website NEW : [www.chromalytic.net.au](http://www.chromalytic.net.au) E-mail : [info@chromtech.net.au](mailto:info@chromtech.net.au) Tel: 03 9762 2034 . . . in AUSTRALIA**

# Clear Moulded Drop Dispensing Bottles – DIN 18mm



CAPS TO SUIT (From Left to Right)

CT18WTPE – 18mm White polypropylene ring seal screw, tamper proof tamper evident cap

CT18BTPE – 18mm Black polypropylene ring seal screw, tamper proof tamper evident cap

CT18WTE – 18mm Black polypropylene ring seal tamper evident cap

CT18BTE – 18mm White polypropylene ring seal tamper evident cap

CT18 -WT – 18mm White T/E poly propylene cap with dripolator inset

\* Polyethylene Dripolator plug is included with cap. (High Flow or regular flow.

PRODUCT CODE								CARTON QUANTITY
CTDD10C	10ml	10.00	12.50	27.50	DIN 18	58.00	24.80	768
CTDD15C	15ml	15.00	20.00	35.00	DIN 18	65.00	28.50	420
CTDD30C	30ml	30.00	35.00	48.00	DIN 18	78.80	33.00	345
CTDD50C	50ml	50.00	57.00	55.00	DIN 18	92.20	37.20	264
CTDD100C	100ml	100.00	105.00	88.00	DIN 18	112.00	44.50	140
CTDD150C	150ml	150.00	155.00	110.00	DIN 18	123.00	50.50	



**Australian Distributors**  
 Importers & Manufacturers  
[www.chromtech.net.au](http://www.chromtech.net.au)

Website NEW : [www.chromalytic.net.au](http://www.chromalytic.net.au) E-mail : [info@chromtech.net.au](mailto:info@chromtech.net.au) Tel: 03 9762 2034 . . . in AUSTRALIA

# Amber Pharma Rounds, 24mm Tampertel Finish



**CAPS TO SUIT (From Left to Right)**

- CT24TER – 24mm White tamper evident polypropylene cap (available with or without wadding)
- CT24STEL – 24mm White tamper evident Child resistant cap (available with or without wadding)
- CTP24B – 24mm polypropylene ring seal screw cap (available with or with wadding)
- CT24S.RSP00 – 24mm White polypropylene ring seal screw caps (available with or without wadding)
- CT28TER – 28mm White tamper evident polypropylene cap (available with or without wadding)
- CT28TEL – 28mm White tamper evident Child resistant cap (available with or without wadding)
- CT28S.RSP00 – 28mm White polypropylene ring seal screw cap (available with or without wadding)
- CTP28B – 28mm Black polypropylene ring seal screw caps (available with or without wadding)



PRODUCT CODE								QUANTITY PER TRAY	QUANTITY PER PALLET
CT50PLC	50ml	50	56.00	56.00	24mm	86.70	37.8	(99 trays x 100 units)	9,900
CT100ZTS	100ml	100	110.7	63.00	24mm	109.80	45.9	(80 trays x 56 units)	4,480
CT200ZGYA	200ml	200	217.5	125.00	24mm	136.00	56.6	(56 trays x 50 units)	2,800 86.7
	500ml	500	534.50	265.00	28mm	183.70	75.4	(45 trays x 25 units)	1,125



**Australian Distributors**  
 Importers & Manufacturers  
[www.chromtech.net.au](http://www.chromtech.net.au)

Website NEW : [www.chromalytic.net.au](http://www.chromalytic.net.au) E-mail : [info@chromtech.net.au](mailto:info@chromtech.net.au) Tel: 03 9762 2034 . . . in AUSTRALIA

# Amber Glass Bottles for Syrups DIN PP 28mm



PRODUCT CODE								CARTON QUANTITY
CTS30A	30ml	30.00	35.00	40.00	DIN 28	67.00	35.00	300
CTS45A	45ml	45.00	50.50	45.00	DIN 28	76.00	36.30	
CTS60A	60ml	60.00	67.50	60.00	DIN 28	94.00	38.60	200
CTS100A	100ml	100.00	108.00	72.00	DIN 28	104.80	46.10	140
CTS125A	125ml	125.00	133.00	90.00	DIN 28	114.40	49.00	210

**HR**OMalytic +61(0)3 9762 2034  
**ECH**nology Pty Ltd

**Australian Distributors**  
 Importers & Manufacturers  
[www.chromtech.net.au](http://www.chromtech.net.au)

Website NEW : [www.chromalytic.net.au](http://www.chromalytic.net.au) E-mail : [info@chromtech.net.au](mailto:info@chromtech.net.au) Tel: 03 9762 2034 . . . in AUSTRALIA

# Clear Glass Bottles for Syrups DIN PP 28mm



PRODUCT CODE							CARTON QUANTITY	
CTS30C	30ml	30.00	35.50	40.00	PP 28	67.00	35.00	
CTS60C	60ml	60.00	67.50	66.00	PP 28	94.50	38.60	
CTS125C	125ml	125.00	133.00	88.00	DIN 28	114.40	49.00	126



**HROMalytic** +61(0)3 9762 2034  
**ECHnology** Pty Ltd

**Australian Distributors**  
 Importers & Manufacturers  
[www.chromtech.net.au](http://www.chromtech.net.au)

**Website NEW : [www.chromalytic.net.au](http://www.chromalytic.net.au) E-mail : [info@chromtech.net.au](mailto:info@chromtech.net.au) Tel: 03 9762 2034 . . . in AUSTRALIA**



# Amber Glass Boston Round – G.P. I 400-18,20,22 mm



PRODUCT CODE								CARTON QUANTITY
CTBR15A	½ oz	14.20	16.40	25.50	18mm – 400	68.26	25.00	
CTBR30A	1 oz	31.30	36.20	44.00	20mm – 400	78.56	32.80	
CTBR60A	2 oz	60.80	63.60	58.00	20mm – 400	93.66	38.60	240
CTBR120A	4 oz	120.00	125.70	108.00	22mm - 400	112.73	48.82	128

**CHROM**alytic +61(0)3 9762 2034  
**ECH**nology Pty Ltd

**Australian Distributors**  
 Importers & Manufacturers  
[www.chromtech.net.au](http://www.chromtech.net.au)

Website NEW : [www.chromalytic.net.au](http://www.chromalytic.net.au) E-mail : [info@chromtech.net.au](mailto:info@chromtech.net.au) Tel: 03 9762 2034 . . . in AUSTRALIA

## Amber Glass Tablet Bottles – Wide Mouth GPI 400



PRODUCT CODE							PALLET QUANTITY
CT460601	60ml	60.00	69.00	73.00	GPI 400-33	75.50	44.50
CT460752	75ml	75.00	86.00	82.00	GPI 400-38	82.50	45.30
CT461003	100ml	100.00	114.00	92.00	GPI 400-38	87.50	50.00
CT461204	120ml	120.00	135.00	110.00	GPI 400-38	95.00	52.80
CT461505	150ml	150.00	170.00	122.00	GPI 400-45	100.00	56.00
CT462006	200ml	200.00	226.00	145.00	GPI 400-45	109.50	61.40
CT462007	250ml	250.00	274.00	170.00	GPI 400-45	117.50	65.30

**HROM**alytic +61(0)3 9762 2034  
**ECH**nology Pty Ltd

**Australian Distributors**  
 Importers & Manufacturers  
[www.chromtech.net.au](http://www.chromtech.net.au)

Website NEW : [www.chromalytic.net.au](http://www.chromalytic.net.au) E-mail : [info@chromtech.net.au](mailto:info@chromtech.net.au) Tel: 03 9762 2034 . . . in AUSTRALIA

## Amber Glass bottles for Syrups PP 18, 20, 22mm



PRODUCT CODE							CARTON QUANTITY
CT420151	15ml	15.00	17.70	31.90	PP 18mm	67.50	27.00
CT420301	30ml	30.00	35.00	46.00	PP 20mm	78.80	33.00
CT420601	60ml	60.00	65.00	74.80	PP 20mm	93.85	40.80
CT421201	120ml	120.00	130.00	97.00	PP 22mm	115.25	48.40
							240
							128

**HROMalytic** +61(0)3 9762 2034  
**ECHnology** Pty Ltd

**Australian Distributors**  
 Importers & Manufacturers  
[www.chromtech.net.au](http://www.chromtech.net.au)

Website NEW : [www.chromalytic.net.au](http://www.chromalytic.net.au) E-mail : [info@chromtech.net.au](mailto:info@chromtech.net.au) Tel: 03 9762 2034 . . . in AUSTRALIA

## Amber Glass Bottles for Syrups Screw Finish STD PP 28mm



PRODUCT CODE							CARTON QUANTITY
CT450501	50ml	50.00	57.00	82.00	PP 28	107.20	35.00
CT450752	75ml	75.00	85.00	105.00	PP 28	107.00	43.00
CT451003	100ml	100.00	110.00	110.00	PP 28	120.70	44.30
CT451004	100ml	100.00	110.00	120.00	PP 28	123.50	44.60
CT451005	100ml	100.00	110.00	120.00	PP 28	126.00	43.20
CT451006	100ml	100.00	110.00	120.00	PP 28	120.00	44.50
CT451007	100ml	100.00	110.00	120.00	PP 28	126.00	44.00
CT451008	100ml	100.00	110.00	120.00	PP 28	123.50	44.60
CT451009	100ml	100.00	110.00	110.00	PP 28	120.70	44.30
CT45150K	150ml	150.00		147.00	PP 28	135.50	52.00

**HROMalytic** +61(0)3 9762 2034  
**ECHnology** Pty Ltd

**Australian Distributors**  
 Importers & Manufacturers  
[www.chromtech.net.au](http://www.chromtech.net.au)

Website NEW : [www.chromalytic.net.au](http://www.chromalytic.net.au) E-mail : [info@chromtech.net.au](mailto:info@chromtech.net.au) Tel: 03 9762 2034 . . . in AUSTRALIA

## Clear Infusion Bottles Type II , Ring Finish ISO SFDA 32mm



PRODUCT CODE							CARTON QUANTITY
CT210501C	50ml	50.00	68.00	60.00	ISO 32	68.00	46.00
CT210508C	50ml	50.00		76.00	28.0mm	80.00	45.30
CT210502C	50ml	50.00		73.50	SFDA 28.3	78.00	46.00
CT211003C	100ml	100.00		99.50	28.8mm	96.00	52.00
CT211001C	100ml	100.00	128.00	100.00	ISO 32	104.00	49.00
CT211002C	100ml	100.00		110.00	SFDA 28.3	110.00	53.00

**HROM**alytic +61(0)3 9762 2034  
**ECH**nology Pty Ltd

**Australian Distributors**  
 Importers & Manufacturers  
[www.chromtech.net.au](http://www.chromtech.net.au)

Website NEW : [www.chromalytic.net.au](http://www.chromalytic.net.au) E-mail : [info@chromtech.net.au](mailto:info@chromtech.net.au) Tel: 03 9762 2034 . . . in AUSTRALIA

# Clear Essence Bottle G.P.I 400



PRODUCT CODE							CARTON QUANTITY
CT320151	15ml	14.20	16.40	25.50	18mm-400	68.26	25.00
CT320301	30ml	31.30	36.20	44.00	20mm-400	78.58	32.80
CT320601	60ml	60.80	63.80	58.00	20mm-400	93.66	38.60
CT320302	30ml	29.20	34.00	72.00	PP 20mm	88.50	34.80
CT320202	20ml	20.00			PP 18mm	98.50	30.00

**HROMalytic** +61(0)3 9762 2034  
**ECHnology** Pty Ltd

**Australian Distributors**  
 Importers & Manufacturers  
[www.chromtech.net.au](http://www.chromtech.net.au)

Website NEW : [www.chromalytic.net.au](http://www.chromalytic.net.au) E-mail : [info@chromtech.net.au](mailto:info@chromtech.net.au) Tel: 03 9762 2034 . . . in AUSTRALIA

# Rubber Bulb Glass Dropper Assemblies



**20MM RED NATURAL RUBBER TEAT**  
**20MM WHITE HOLE CAP**  
**WITH STRAIGHT GLASS STEM**

- CTGD2045RW 45MM STRAIGHT GLASS STEM
- CTGD2060RW 60MM STRAIGHT GLASS STEM
- CTGD2067RW 67MM STRAIGHT GLASS STEM
- CTGD2070RW 70MM STRAIGHT GLASS STEM
- CTGD2077RW 77MM STRAIGHT GLASS STEM
- CTGD2080RW 80MM STRAIGHT GLASS STEM
- CTGD2097RW 97MM STRAIGHT GLASS STEM
- CTGD20110RW 110MM STRAIGHT GLASS STEM

**20MM BLACK NITRILE RUBBER TEAT**  
**20MM WHITE HOLE CAP**  
**WITH STRAIGHT GLASS STEM**

- CTGD4520BW 45MM STRAIGHT GLASS STEM
- CTGD6020BW 60MM STRAIGHT GLASS STEM
- CTGD6720BW 67MM STRAIGHT GLASS STEM
- CTGD7020BW 70MM STRAIGHT GLASS STEM
- CTGD7720BW 77MM STRAIGHT GLASS STEM
- CTGD8020BW 80MM STRAIGHT GLASS STEM
- CTGD9720BW 97MM STRAIGHT GLASS STEM
- CTGD11020BW 110MM STRAIGHT GLASS STEM

**22MM RED NATURAL RUBBER TEAT**  
**22MM WHITE HOLE CAP**  
**WITH STRAIGHT GLASS STEM**

- CTGD4522RW 45MM STRAIGHT GLASS STEM
- CTGD6022RW 60MM STRAIGHT GLASS STEM
- CTGD6722RW 67MM STRAIGHT GLASS STEM
- CTGD7022RW 70MM STRAIGHT GLASS STEM
- CTGD7722RW 77MM STRAIGHT GLASS STEM
- CTGD8022RW 80MM STRAIGHT GLASS STEM
- CTGD9722RW 97MM STRAIGHT GLASS STEM
- CTGD11022RW 110MM STRAIGHT GLASS STEM

**22MM RED NATURAL RUBBER TEAT**  
**24MM WHITE HOLE CAP**  
**WITH STRAIGHT GLASS STEM**

- CTGD4524RW 45MM STRAIGHT GLASS STEM
- CTGD6024RW 60MM STRAIGHT GLASS STEM
- CTGD6724RW 67MM STRAIGHT GLASS STEM
- CTGD7024RW 70MM STRAIGHT GLASS STEM
- CTGD7724RW 77MM STRAIGHT GLASS STEM
- CTGD8024RW 80MM STRAIGHT GLASS STEM
- CTGD9724RW 97MM STRAIGHT GLASS STEM
- CTGD11024RW 110MM STRAIGHT GLASS STEM

**24MM BLACK NITRILE RUBBER TEAT**  
**24MM WHITE HOLE CAP**  
**WITH STRAIGHT GLASS STEM**

- CTGD4524BW 45MM STRAIGHT GLASS STEM
- CTGD6024BW 60MM STRAIGHT GLASS STEM
- CTGD6724BW 67MM STRAIGHT GLASS STEM
- CTGD7024BW 70MM STRAIGHT GLASS STEM
- CTGD7724BW 77MM STRAIGHT GLASS STEM
- CTGD8024BW 80MM STRAIGHT GLASS STEM
- CTGD9724BW 97MM STRAIGHT GLASS STEM
- CTGD11024BW 110MM STRAIGHT GLASS STEM

MATERIAL	SUITABILITY
NITRILE RUBBER	PETROL
	AROMATIC HYRO-CARBONS
	OILS

MATERIAL	SUITABILITY
NATURAL RUBBER	ACIDS
	CAUSTICS
	CHLORINE
	WATER
	KETONES
	ALCOHOL
	ESTERS

ALL DIFFERENT COLOUR COMBINATIONS & SIZES ARE AVAILABLE ON REQUEST.



**HROMalytic** +61(0)3 9762 2034  
**ECHnology** Pty Ltd

**Australian Distributors**  
 Importers & Manufacturers  
[www.chromtech.net.au](http://www.chromtech.net.au)

**Website NEW : [www.chromalytic.net.au](http://www.chromalytic.net.au) E-mail : [info@chromtech.net.au](mailto:info@chromtech.net.au) Tel: 03 9762 2034 . . . in AUSTRALIA**

## Fine Mist Sprayer Pumps & Lotion Pumps [Screw version]



\* Different colours for actuator, closure and dustcap are available upon request.

\* Different Lengths of dip tubes are available upon request



**HROM**alytic +61(0)3 9762 2034  
**ECH**nology Pty Ltd

**Australian Distributors**  
Importers & Manufacturers  
[www.chromtech.net.au](http://www.chromtech.net.au)

Website NEW : [www.chromalytic.net.au](http://www.chromalytic.net.au) E-mail : [info@chromtech.net.au](mailto:info@chromtech.net.au) Tel: 03 9762 2034 . . . in AUSTRALIA



# Polypropylene ring seal screw caps ~ LDPE Push-in Caps



## SCREW CAPS

PRODUCT CODE	DESCRIPTION	TO SUIT
CT10SRSP00	10mm Black polypropylene ring seal screw cap	CT502219B, CT502219 -AM
CT18R	18mm White polypropylene ring seal screw cap	CT502015B, CTB02158S, CTB02161S, CT502108B, CT1218SCR
CT18 BTE	18mm Black din finish polypropylene tamper evident cap, with polyethylene driplator plug	CTDD5A, CTDD10A, CTDD15A, CTDD20A, CTDD25A, CTDD30A, CTDD50A, CTDD100A
CT18 BTPE	18mm White din finish polypropylene tamper evident cap & tamper proof, with polyethylene driplator plug	CTDD5A, CTDD10A, CTDD15A, CTDD20A, CTDD25A, CTDD30A, CTDD50A, CTDD100A
CT18 -WT	18mm 18mm White din finish polypropylene tamper evident cap, with polyethylene driplator plug	CTDD5A, CTDD10A, CTDD15A, CTDD20A, CTDD25A, CTDD30A, CTDD50A, CTDD100A
CT18 WTPE	18mm White din finish polypropylene tamper evident cap & tamper proof, with polyethylene driplator plug	CTDD5A, CTDD10A, CTDD15A, CTDD20A, CTDD25A, CTDD30A, CTDD50A, CTDD100A
CT517805C	20mm White polypropylene ring seal screw cap	CT502022B, CT502021B, CTPY15A, CTPY25A
CT20RSP000	20mm Black polypropylene ring seal screw cap	CT502022B, CT502021B, CTPY15A, CTPY25A
CT22RSP000	22mm White polypropylene ring seal screw cap	CT502039B, CT502210B, CT502210S, CTB02053S, CTB02215B,
CT24S.RSP00	24mm White polypropylene ring seal screw cap	CT502105B, CT502155A, CT502050B, CT502215A, CT40MA
CTP24B	24mm Black polypropylene wadded ring seal cap	CT502105B, CT502155A, CT502050B, CT502215A, CT40MA, CT502TS, CT100ZTS, CT200ZTS, CT500ZTS

\* Celloseal, Aluminum induction foil seal & Teflon wadding is available on request

## PUSH-IN CAPS

PRODUCT CODE	DESCRIPTION	TO SUIT
CTP1466W	White LDPE ¼" push-in cap	CT10B
CT507801C	White LDPE ½" push-in cap	CT501011B, CT12B
CTP1066W	White LDPE 1" push-in cap	CT501060B, CT24B



**HROMalytic** +61(0)3 9762 2034  
**ECHnology** Pty Ltd

**Australian Distributors**  
 Importers & Manufacturers  
[www.chromtech.net.au](http://www.chromtech.net.au)

Website NEW : [www.chromalytic.net.au](http://www.chromalytic.net.au) E-mail : [info@chromtech.net.au](mailto:info@chromtech.net.au) Tel: 03 9762 2034 . . . in AUSTRALIA

# Polypropylene Caps & Polyethylene Dripolator Plugs



Each cap comes with either a Regular flow or High flow dripolator plug



PRODUCT CODE	DESCRIPTION	TO SUIT	
CT18BTPE	18mm Black DIN finish polypropylene Tamper-proof, Tamper Evident screw cap	CTDD5A CTDD10A CTDD15A CTDD20A CTDD25A CTDD30A CTDD50A CTDD100A	5ml Amber Type 3 glass bottle
CT18WTPE	18mm White DIN finish polypropylene Tamper-proof, Tamper Evident screw cap		10ml Amber Type 3 glass bottle
CT18WTE	18mm White DIN finish polypropylene Tamper-proof, screw cap		15ml Amber Type 3 glass bottle
CT18BTE	18mm Black DIN finish polypropylene Tamper-proof, screw cap		20ml Amber Type 3 glass bottle
CT18 -WT	18mm White DIN finish polypropylene Tamper-proof, screw cap with dripolator plug insert		25ml Amber Type 3 glass bottle
			30ml Amber Type 3 glass bottle
			50ml Amber Type 3 glass bottle
			100ml Amber Type 3 glass bottle



PRODUCT CODE: CT18WTPE



PRODUCT CODE: CT18BTPE



PRODUCT CODE: CT18WTE



PRODUCT CODE: CT18BTE



PRODUCT CODE: CT18 -WT



**HROMalytic** +61(0)3 9762 2034  
**ECHnology** Pty Ltd

**Australian Distributors**  
 Importers & Manufacturers  
[www.chromtech.net.au](http://www.chromtech.net.au)

Website NEW : [www.chromalytic.net.au](http://www.chromalytic.net.au) E-mail : [info@chromtech.net.au](mailto:info@chromtech.net.au) Tel: 03 9762 2034 . . . in AUSTRALIA

# Polypropylene Tamper Evident Child Resistant Caps



PRODUCT CODE	DESCRIPTION	TO SUIT
CTC24TEL	24mm White polypropylene tamper evident cap with wadding liner	CT50ZTS, CT100ZTS, CT200ZTS, CT500ZTS
CTC24STEL	24mm White polypropylene Child resistant tamper evident cap with wadding liner	CT50ZTS, CT100ZTS, CT200ZTS, CT500ZTS
CTC28TER	28mm White polypropylene tamper evident cap with wadding liner	CTS30A, CTS45A, CTS60A, CTS100A, CTS125A
CTC28S2TEL	28mm White polypropylene Child resistant tamper evident cap with wadding liner	CTS30A, CTS45A, CTS60A, CTS100A, CTS125A



**HROM**alytic +61(0)3 9762 2034  
**ECH**nology Pty Ltd

**Australian Distributors**  
 Importers & Manufacturers  
[www.chromtech.net.au](http://www.chromtech.net.au)

Website NEW : [www.chromalytic.net.au](http://www.chromalytic.net.au) E-mail : [info@chromtech.net.au](mailto:info@chromtech.net.au) Tel: 03 9762 2034 . . . in AUSTRALIA

# Freeze Drying Closures for Injection Vials 13mm & 20mm



CT-20BNRB-2L



CT-13BNRB-2L



<b>Ref No.:</b>	CT20 -D2
<b>Size:</b>	20.00mm
<b>OD of Flange:</b>	18.80mm
<b>ID of Neck:</b>	13.20mm
<b>Height of Flange:</b>	03.30mm
<b>Total Height:</b>	14.00mm
<b>Pack Size:</b>	1,000 units

<b>Ref No.:</b>	CT13 -D2
<b>Size:</b>	13.00mm
<b>OD of Flange:</b>	12.50mm
<b>ID of Neck:</b>	07.50mm
<b>Height of Flange:</b>	02.00mm
<b>Total Height:</b>	10.20mm
<b>Pack Size:</b>	1,000 units

<b>Ref No.:</b>	CT722003
<b>Size:</b>	20.00mm
<b>OD of Flange:</b>	18.80mm
<b>ID of Neck:</b>	13.10mm
<b>Height of Flange:</b>	03.30mm
<b>Total Height:</b>	13.80mm
<b>Pack Size:</b>	1,000 units

## Closures for Injection Vials 13mm & 20mm



CT-20BNRB



CT-13BNRB-C



CT-20BNRB-C

<b>Ref No.:</b>	CT20 -A /CT-20BNRB
<b>Size:</b>	20.00mm
<b>OD of Flange:</b>	18.80mm
<b>ID of Neck:</b>	13.20mm
<b>Height of Flange:</b>	03.30mm
<b>Total Height:</b>	14.00mm
<b>Pack Size:</b>	1,000 units

<b>RNo.:</b>	CT13 -A /CT-13BNRB-C
<b>Size:</b>	13.00mm
<b>OD of Flange:</b>	12.50mm
<b>ID of Neck:</b>	07.50mm
<b>Height of Flange:</b>	02.00mm
<b>Total Height:</b>	07.00mm
<b>Pack Size:</b>	1,000 units

<b>RNo.:</b>	CT20 -B2-01/CT-20BNRB-C
<b>Size:</b>	20.00mm
<b>OD of Flange:</b>	18.80mm
<b>ID of Neck:</b>	13.10mm
<b>Height of Flange:</b>	03.30mm
<b>Total Height:</b>	13.80mm
<b>Pack Size:</b>	1,000 units

## Manual Hand Crimpers & De-cappers



Product Code: CTCRIMP -11S  
 Description: 11 mm Manual Hand Crimper  
 Suitability: Regular crimp closures

Product Code: DECAPPER-11  
 Description: 11 mm Manual Decapper  
 Suitability: Regular & Flip off crimp closures

Product Code: CTCRIMP -13S  
 Description: 13 mm Manual Hand Crimper  
 Suitability: Regular crimp closures

Product Code: DECAPPER-13  
 Description: 13 mm Manual Decapper  
 Suitability: Regular & Flip off crimp closures

Product Code: CTCRIMP -13FO  
 Description: 13 mm Manual Hand Crimper  
 Suitability: Regular Flip off crimp closures

Product Code: CTCRIMP -20S  
 Description: 20mm Manual Hand Crimper  
 Suitability: Regular crimp closures

Product Code: CTCRIMP -20FO  
 Description: 20 mm Manual Hand Crimper  
 Suitability: Regular Flip off crimp closures

Product Code: DECAPPER-20  
 Description: 20 mm Manual Decapper  
 Suitability: Regular & Flip off crimp closures

**\*\*\* Battery operated hand crimpers and De-cappers are also available on request \*\*\***

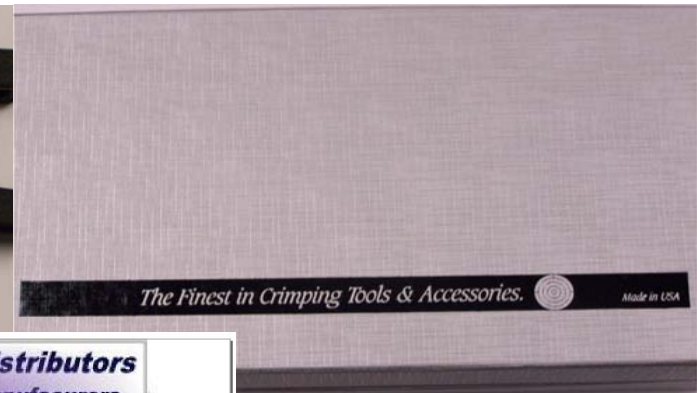

**HROMalytic** +61(0)3 9762 2034  
**ECHnology** Pty Ltd

**Australian Distributors**  
 Importers & Manufacturers  
[www.chromtech.net.au](http://www.chromtech.net.au)

Website NEW : [www.chromalytic.net.au](http://www.chromalytic.net.au) E-mail : [info@chromtech.net.au](mailto:info@chromtech.net.au) Tel: 03 9762 2034 . . . in AUSTRALIA



# Technical Certificates



THE INTERNATIONAL CERTIFICATION NETWORK

## CERTIFICATE

IQNet and CQM  
hereby certify that the organization  
**Shandong Pharmaceutical Glass Co., Ltd.**  
Domicile: Yiyuan County, Zibo City, Shandong, P.R.China  
Certification Add.: Yaocou Road, Yiyuan County, Zibo City, Shandong, P.R.China  
Post code.: 256100  
is in conformity with  
**ISO 14001:2004 Standard**

This certificate is valid to the following product(s)/service:  
Design, manufacture and sale of the injection vials made of moulded soda lime glass, infusion bottles made of soda lime glass, medicinal bottles made of soda lime glass, pharmaceutical tube made of low borosilicate glass, injection vials made of low borosilicate glass tubing, oral liquid bottles made of low borosilicate glass tubing, ampoules made of low borosilicate glass tubing, pharmaceutical tube made of neutral borosilicate glass, injection vials made of moulded neutral borosilicate glass tubing, pharmaceutical tube made of neutral borosilicate glass, injection vials made of neutral borosilicate glass tubing, infusion bottles made of neutral borosilicate glass, ampoules made of neutral borosilicate glass tubing and relevant management activities

For the certification scope of the subsidiary place to the following table

Organization	Certification Address	Products/activities
Tamen Branch Company	Tamen Town, Yiyuan County, Shandong, P.R.China	Design, manufacture of the pharmaceutical tube made of low borosilicate glass, injection vials made of low borosilicate glass tubing, oral liquid bottles made of low borosilicate glass tubing, ampoules made of low borosilicate glass tubing, injection vials made of moulded neutral borosilicate glass, ampoules made of neutral borosilicate glass tubing
Ancher Bottle In Industrial Park	Industrial Park, Yiyuan County, Shandong, P.R.China	Manufacture of the medicinal bottles made of soda lime glass

Issued on: 2009-11-25  
Validity date: 2012-11-24  
Registration Number: CN-00209E21550R0L

  
  
**René Wasmer**  
President of IQNet

  
**Zhang Wei**  
CEO of CQM



\*The list of IQNet partners is valid at the time of issue of this certificate. Updated information is available under [www.iqnet-certification.com](http://www.iqnet-certification.com)



THE INTERNATIONAL CERTIFICATION NETWORK

## CERTIFICATE

IQNet and CQM  
hereby certify that the organization  
**Shandong Pharmaceutical Glass Co., Ltd.**  
Domicile: Yiyuan County, Zibo City, Shandong, P.R.China  
Certification Add.: Yaocou Road, Yiyuan County, Zibo City, Shandong, P.R.China  
Post code.: 256100  
is in conformity with  
**ISO 9001:2008 Standard**

This certificate is valid to the following product(s)/service:  
Design, manufacture and sale of the injection vials made of moulded soda lime glass, infusion bottles made of soda lime glass, medicinal bottles made of soda lime glass, pharmaceutical tube made of low borosilicate glass, injection vials made of low borosilicate glass tubing, oral liquid bottles made of low borosilicate glass tubing, ampoules made of low borosilicate glass tubing, pharmaceutical tube made of neutral borosilicate glass, injection vials made of moulded neutral borosilicate glass, injection vials made of neutral borosilicate glass tubing, infusion bottles made of neutral borosilicate glass, ampoules made of neutral borosilicate glass tubing

For the certification scope of the subsidiary place to the following table

Organization	Certification Address	Products/activities
Tamen Branch Company	Tamen Town, Yiyuan County, Shandong, P.R.China	Design, manufacture of the pharmaceutical tube made of low borosilicate glass, injection vials made of low borosilicate glass tubing, oral liquid bottles made of low borosilicate glass tubing, ampoules made of low borosilicate glass tubing, injection vials made of moulded neutral borosilicate glass, ampoules made of neutral borosilicate glass tubing
Ancher Bottle In Industrial Park	Industrial Park, Yiyuan County, Shandong, P.R.China	Manufacture of the medicinal bottles made of soda lime glass

Issued on: 2009-11-25  
Validity date: 2012-11-24  
Registration Number: CN-00209Q16136R0L

  
  
**René Wasmer**  
President of IQNet

  
**Zhang Wei**  
CEO of CQM



\*The list of IQNet partners is valid at the time of issue of this certificate. Updated information is available under [www.iqnet-certification.com](http://www.iqnet-certification.com)



THE INTERNATIONAL CERTIFICATION NETWORK

## CERTIFICATE

IQNet and CQM  
hereby certify that the organization  
**Shandong Pharmaceutical Glass Co., Ltd.**  
Domicile: Yiyuan County, Zibo City, Shandong, P.R.China  
Certification Add.: Yaocou Road, Yiyuan County, Zibo City, Shandong, P.R.China  
Post code.: 256100  
is in conformity with  
**ISO 9001:2008 Standard**

This certificate is valid to the following product(s)/service:  
Design, manufacture and sale of the injection vials made of moulded soda lime glass, infusion bottles made of soda lime glass, medicinal bottles made of soda lime glass, pharmaceutical tube made of low borosilicate glass, injection vials made of low borosilicate glass tubing, oral liquid bottles made of low borosilicate glass tubing, ampoules made of low borosilicate glass tubing, pharmaceutical tube made of neutral borosilicate glass, injection vials made of moulded neutral borosilicate glass, injection vials made of neutral borosilicate glass tubing, infusion bottles made of neutral borosilicate glass, ampoules made of neutral borosilicate glass tubing

For the certification scope of the subsidiary place to the following table

Organization	Certification Address	Products/activities
Tamen Branch Company	Tamen Town, Yiyuan County, Shandong, P.R.China	Design, manufacture of the pharmaceutical tube made of low borosilicate glass, injection vials made of low borosilicate glass tubing, oral liquid bottles made of low borosilicate glass tubing, ampoules made of low borosilicate glass tubing, injection vials made of moulded neutral borosilicate glass, ampoules made of neutral borosilicate glass tubing
Ancher Bottle In Industrial Park	Industrial Park, Yiyuan County, Shandong, P.R.China	Manufacture of the medicinal bottles made of soda lime glass

Issued on: 2009-11-25  
Validity date: 2012-11-24  
Registration Number: CN-00209Q16136R0L

  
  
**René Wasmer**  
President of IQNet

  
**Zhang Wei**  
CEO of CQM



\*The list of IQNet partners is valid at the time of issue of this certificate. Updated information is available under [www.iqnet-certification.com](http://www.iqnet-certification.com)



**HRoMalytic** +61(0)3 9762 2034

**ECHnology** Pty Ltd

**Australian Distributors**  
Importers & Manufacturers  
[www.chromtech.net.au](http://www.chromtech.net.au)

Website NEW : [www.chromalytic.net.au](http://www.chromalytic.net.au) E-mail : [info@chromtech.net.au](mailto:info@chromtech.net.au) Tel: 03 9762 2034 . . . in AUSTRALIA



# Technical Certificates

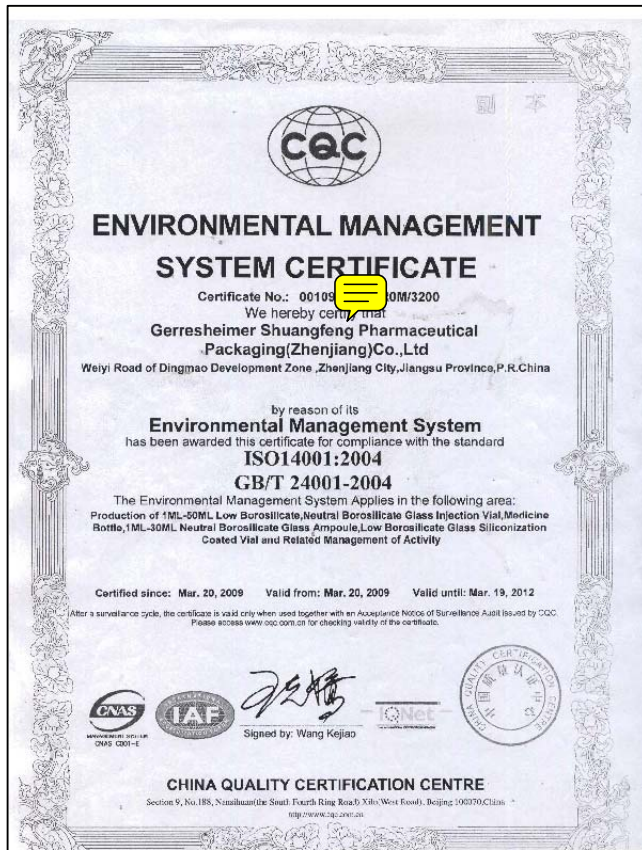

**HRoMalytic** +61(0)3 9762 2034  
**ECHnology** Pty Ltd

**Australian Distributors**  
 Importers & Manufacturers  
[www.chromtech.net.au](http://www.chromtech.net.au)

Website NEW : [www.chromalytic.net.au](http://www.chromalytic.net.au) E-mail : [info@chromtech.net.au](mailto:info@chromtech.net.au) Tel: 03 9762 2034 . . . in AUSTRALIA

# **VIALS & BOTTLES : Products Catalog**

## **SCREW and Crimp Caps**



**HROM**alytic +61(0)3 9762 2034  
**ECH**nology Pty Ltd

**Australian Distributors**  
Importers & Manufacturers  
[www.chromtech.net.au](http://www.chromtech.net.au)

Website NEW : [www.chromalytic.net.au](http://www.chromalytic.net.au) E-mail : [info@chromtech.net.au](mailto:info@chromtech.net.au) Tel: 03 9762 2034 . . . in AUSTRALIA

# Serum Vials & Accessories

*some of... Chromalytics... more popular Items*

## 13mm and 20mm Crimp Top Vials

CTSC-10V-20T-22D45H 198ea per slab also 2.5, 4.5, 7.5, 20/23, 30, 50, 100ml  
 CTSA-13V-20T-24D49H 155ea per slab Slab Qtys vary with size  
 CTSC-20V-20T-26D66H 85ea per slab **Clear** . . . some **Amber**  
 CTSA-23V-20T-29D60HTP 113ea per slab

**we do NOT split slabs**



## Crimp Top Caps

13 and 20mm

### Plain Aluminium Centre Tear-out :

CT-20CTO-Crimp-X

### FlipOff Crimp Tops

many Colors -X  
**ASK!**

2 Types - Plain Color Cap CT-20KFO-Crimp-X

CT-20WPFO-Crimp-X ("FLIP OFF")



## Gray Rubber Stoppers

Chlorobutyl Rubber CT-20BNRB-C

13 and 20mm  
RoundBottom  
also 2-leg freeze dry



## Crimping & Decapping Tools

Hand Crimper CT-CRIMP-20S  
CT-CRIMP-20FO

Electronic Crimper

Bench Top Crimper

Pneumatic Crimper



## Dispensers

Syringe Dispenser CT-FDS-10

BottleTop Dispenser  
10ml BTD-3

also 2.5, 5, 10, 30ml



## Filtration

### Syringe Filter

Nylon, PVDF, PTFE, PES  
0.22 and 0.45um  
Serile / Non-sterile  
13, 25mm



### Membrane Filters



Nylon, PVDF, PTFE, PES, Glass Fibre  
0.22 and 0.45um

### Filtration Equipment Glass Vacuum System Hand VAC Pumps

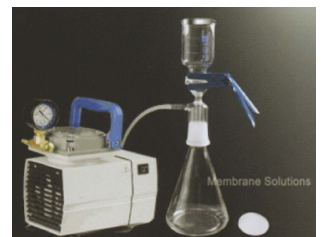



## Hand Crimper

- High quality construction for durability and long life.
  - Consistent dependable performance.
  - Smooth simple operation.
  - Painted, plated or coated for maximum corrosion resistance
  - Less expensive than competitive models.
  - All parts that contact the container cap are **electrodeless nickel-plated** or **stainless steel**. The benefits include high corrosion resistance and good lubricity have been proven through extensive laboratory and field testing.
  - Textured handle surfaces provide a better grip than smooth painted models. The powder coating used to paint the handles is durable and scratch resistant. The coating process is environmentally clean—no toxic fumes or hazardous wastes are generated. The handle clip, pins and screws are made of corrosion resistant stainless steel.
- Sizes** : 20mm, 13,, 11mm, 8mm for Standard Caps and Plastic Flipoff Caps.

## Vial Caps

- 13mm, 20mm Color Coded
- CentreTearOut Option Side TearOut ( to order )
- Plastic FlipOff



## Serum Stoppers

- 13mm, 20mm
- 2-Legged Freeze
- Chlorobutyl Rubber
- Butyl Rubber
- Silicone Rubber
- Teflon Coated



**Vial Kit** : Slab of Vials + Crimper + Caps + Stoppers SPECIAL Discount - **15% off List Price**  
**Or if Order value >\$500**

## Vial Accessories

- Syringe Filters
- Filter Funnels, Flasks ( & Vacuum Pump )
- Membrane Filters
- Stoppers
- Caps
- Syringe Dispenser
- Hand Crimper also
- Bench Crimper
- Pneumatic Crimper



# 13 & 20mm Glass Serum Vial Caps

/ 2010 - Chromalytic

see Updated WPFO Range 2011 page 2

## Centre TearOut

CT-13CTO-X  
CT-20CTO-X

ÄËËI ^æ

YES in Stock Melb  
X=Color ( specify )



## FLIP Off

CT-13WPFO-X  
CT-20WPFO-X

ÄËËI

YES in Stock Melb  
X=Color ( specify )  
"FLIP OFF" on lid



CT-13KFO-X  
CT-20KFO-X

ÄËËI

YES in Stock Melb  
X=Color ( specify )  
Plain Finish lid



Most Caps : Styles  
& Colors  
kept in Stock Melb !

## 20mm Side TearOut Caps (Plain)

CT-20STO-X \$0.24each  
limited range of col ors

32mm PLAIN Caps CT-32CTO-CRIMP-Nat \$0.30ea  
32mm Stoppers CT-BNRB \$0.30ea  
32mm 100ml Glass Bottles CTSC-100V-32T \$1.10ea

## Chlorbutyl Rubber Stoppers



13 & 20mm  
Round Bottom

13 & 20mm  
2-Legged  
Lyophilisation  
Freeze-Dry Type

CT-13BNRB-C  
CT-20BNRB-C  
\$0.24ea

CT-13BNRB-FD1  
CT-20BNRB-FD1  
\$0.30ea

Caps and Stoppers available for both  
13mm and 20mm Diameter Neck Vials

FlipOff design exposed rubber  
through Open-Hole in Aluminium  
underlying Cap

Older Style - Butyl Rubber CT-20BNRB  
still Available ( softer Rubber )

## OPTIONS . . .

Red 20mm RB Stoppers  
CT-20BNRB-R \$0.24ea  
Silicone Coated Butyl Stopper  
CT-20BNRB-C \$0.30ea

# 13 & 20mm WP FlipOff Caps

## 2011

**20mm**

**CT-20WPFO-Crimp-X** ~~AET~~

**X : Color**



**13mm**

**CT-13WPFO-Crimp-X \$0.24ea**







**Chromalytic Amber Vials**  
(from left to right)

CatNo	Description	Liquid in vial	Slab Size	Slab Price	Each Price
CTSCW-100V-20T-52D94H	100ml Amber glass type (2) Vial Sulphur Teated and Washed 20mm Crimp Finish	100ml	66	\$58.08	\$1.05
CTSA-23V-20T-29D60H	23ml Amber Glass Schott Vial 20mm Crimp Finish	20ml	113	94.92	\$0.88
CTSA-13V-20T-24D49H	13ml Amber Glass Schott Vial 20mm Crimp Finish	10ml	155	\$102.30	\$0.77

**Other Amber Vials Not Necessarily Stocked**  
(refer to clear vials for similar vial image)

CatNo	Description	Liquid in vial	Slab Size	Slab Price	Each Price
CTSAW-50V-20T-43D73H	50ml Amber glass type (2)Vial Sulphur Teated and Washed 20mm Crimp Finish	50ml	112	Call	Call
CTSA-7V-20T-22D38H	7ml Amber Glass Schott Vial 20mm Crimp Finish	7ml	241	Call	Call
CTSA-2V-13T-15D32H	2ml Amber Glass Schott Vial 13mm Crimp Finish	2ml	371	Call	Call



**Clear Vials**



**50/20      23/20      20/20      13/20      13/10      10/20      10/13      7/20      4/13      2/13**

*Nominal Volume (ml) / actual Liquid Volume / Neck Size (mm) - Stoppers shown in place No Alum Caps shown*

*Vials supplied Clean - Shrink-wrapped in slabs (NOT Sterile) and Empty*

**Amber Vials**



**100/20      23/20      13/20**

**Stoppers 20mm ( and 13mm )**

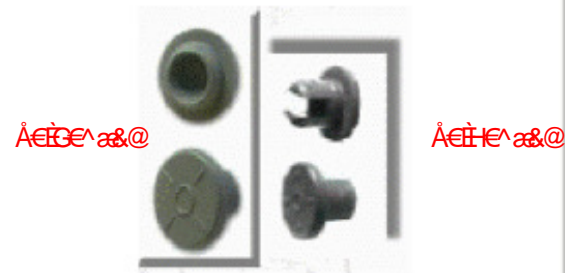

**Chlorobutyl (darkGry)**

**CT-20BNRB-C      CT-20BNRB-2L**

Round Bottom      2-Leg Freeze Dry

**Standard      Custom**

CT-20BNRB Butyl (LtGry)   
 Butyl (Red) CT-20BNRB-R 



**30/30ml**  
**29x52mm**

**CTSC-30V-20T29H52W**



**20/20ml**  
**45x25mm**

**CTSC-20V-20T45H25W**



**20/23ml**  
**49x29mm**

**CTSC-23V-20T-49H29W**



**10/13ml**  
**28.5x24mm**

**CTSC-13V-20T28H24W**



**10/10ml**  
**45x22mm**

**CTSC-10V-20T45H22W**



**10/10ml-S**  
**40x25.5mm**

**CTSC-10V-20T40H25W**

**HROM**alytic +61(0)3 9762 2034  
**ECH**nology Pty Ltd

**Australian Distributors**  
Importers & Manufacturers  
[www.chromtech.net.au](http://www.chromtech.net.au)

Website NEW : [www.chromalytic.net.au](http://www.chromalytic.net.au) E-mail : [info@chromtech.net.au](mailto:info@chromtech.net.au) Tel: 03 9762 2034 . . . in AUSTRALIA



# Chromalytic Technology PRICE LIST

## Vial Accessories

Tel : 03 9762 2034 Website : [www.chromtech.com.au/vials.htm](http://www.chromtech.com.au/vials.htm)

<b>CrimpTop Vials</b>		<b>Finish</b>	<b>To Order</b>	<b>Price</b>	<b>No/ Slab</b>	<b>Kg</b>			
<b>Vials - Clear</b>	<b>Volume mL</b>	<b>mm Size</b>	<b>Cat.# +DIM in mm</b>	<b>\$</b>					
	2	13	CTSC-2V-13T	0.39	371				
	4	13	CTSC-4V-13T-16D38H	0.39	368				
	7	20	CTSC-7V-20T-22D38H	0.60					
	10	13	CTSC-10V-13T-22D45H	0.66	198	1.8			
		20	CTSC-10V-20T-22D45H	0.66	198	1.8			
	13	13	CTSC-13V-13T-24D50H	0.66	155				
		20	CTSC-13V-20T-24D49H	0.66	155				
	20	20	CTSC-20V-20T-26D66H	0.77					
	50	20	CTSC-50V-20T-43D73H	0.77	66				
	100	20	CTSCW-100V-20T-52D95H	0.92					
		32	CTSC-100V-20T-49D103H	1.10					
<b>Vials - Amber</b>	2	13	CTSA-2V-13T-15D32H	0.42					
	7	20	CTSA-7V-20T-22D38H	0.66					
	13	20	CTSA-13V-20T-24D50HTP	0.77	145	1.8			
	23	20	CTSA-23V-20T-29D60HTP	0.85	113				
	27	20	CTSA-27V-20T-32D57H	0.85					
	50	20	CTSAW-50V-20T-43D73H	0.90	66				
<b>Hand Crimper</b>	Standard	13	CT-Crimp-13S	<del>G 1.00</del>					
	FlipOff	13	CT-Crimp-13FO	<del>G 1.00</del>					
	Standard	20	CT-Crimp-20S	<del>G 1.00</del>					
	FlipOff	20	CT-Crimp-20FO	<del>G 1.00</del>					
	Standard	32	CT-Crimp-32S	372.00					
<b>Bench Crimper</b>		13,20,32	Screw-on Heads	Ask		8			
<b>Pneumatic Crimper</b>		13,20,32	Screw-on Heads	Ask		10			
<b>Decappers</b>	Hand	13,20		<del>G 1.00</del>					
	Plier Type	13,20		75.00					
<b>Caps</b>									
<b>Plain CTO</b>		13	CT-13CTO-Crimp-X	<del>€1.00</del>					
X=Color ( from 8 )		20	CT-13CTO-Crimp-X	<del>€1.00</del>					
		32	CT-13CTO-Crimp-Nat	<del>€1.00</del>					
<b>Plain FlipOFF</b>		13	CT-13KFO-Crimp-X	0.24					
X=Color ( from 9 )		20	CT-13KFO-Crimp-X	0.24					
<b>"FLIPOFF" FO</b>		13	CT-13WPFO-Crimp-X	0.30					
X=Color ( from 18 )		20	CT-13WPFO-Crimp-X	0.30					
<b>Stoppers</b>									
RoundBottom	chlorobutyl	13mm	CT-13BNRB-C	<del>€0.35</del>					
	chlorobutyl	20mm	CT-20BNRB-C	<del>€0.35</del>					
	butyl	32mm	CT-32BNRB	0.35					
2-Leg FreezeDry	chlorobutyl	13mm	CT-13BNFD-C	0.30					
	chlorobutyl	20mm	CT-20BNFD-C	0.35					
<b>10ml Syringe Dispenser</b>	10ml		CT-SD-10	65.00					
<b>Bottle Top Dispenser</b>	10ml		BTD-3	<del>G 1.00</del>					
<b>Bottles GL-45 Thread</b>	250	GL-45	CG-GBGL45-250	10.00					
	500		CG-GBGL45-500	18.00					
	1000		CG-GBGL45-1000	28.00					
	2000		CG-GBGL45-2000-SC	95.00					
<b>Discount</b>	<b>15%</b>	<b>Total Order &gt;\$500</b>							
	<b>25%</b>	<b>&gt;\$2500</b>							
Prices are ex GST									
<b>Freight ( Courier Only for Vials )</b>		Melb Metro	based on Weight \$12 per 5kg						
		Interstate	Metro	\$20 per 5kg		<b>Website</b> <a href="http://www.chromtech.net.au">www.chromtech.net.au</a>			
<b>Conditions</b>		Signature Required				<b>NEW :</b> <a href="http://www.chromalytic.com.au">www.chromalytic.com.au</a>			
<b>NO CLAIMS!</b>		Glass Breakage at Customers Risk							

## Catalog No Vials & Caps Overview

Catalog No	Nominal Volume	Type	Size HtxOD	Qty/Slab	Description	Page No
CT10B	3	Test Tube	75x10	250	Clear Borosilicate Glass Test Tubes	4
CT12B	5	Test Tube	75x12	250		4
CT13B	9	Test Tube	100x13	250		4
CT16B	14	Test Tube	100x16	250		4
CT166B	22	Test Tube	150x13.8	250		4
CT18B	28	Test Tube	150x18	250		4
CT20B	34	Test Tube	150x20	250		4
CT24B	50	Test Tube	150x24	250		4
CT24B1	50	Test Tube	150x24	250		4
CT02SCAMP	2	Ampules	11.5	455		Clear Borosilicate Glass Ampules
CT05SCAMP	5	Ampules	16	480	5	
CT10SCAMP	10	Ampules	18.4	272	5	
CT01SAAMP	1	Ampules	10	348	Amber Borosilicate Glass Ampules	6
CT02SAAMP	2	Ampules	11.5	455		6
CT05SAAMP	5	Ampules	16	480		6
CT10SAAMP	10	Ampules	18.4	272		6

Catalog No	Nominal Volume	Type	Size HtxOD	Qty/Slab	Description	Page No
CT501060B	18	Spec Tubes	50.8x22.8	1000	Clear Borosilicate Type 1 Specimen Tubes	7
CT501011B	4	Spec Tubes	48x11.2	3592		7
CTF215518B	3	Crimp	38.75x16.25	3060	Clear Borosilicate Type 1 glass vials, 13mm Crimp Finish	8
CT505243B	7	Crimp	37.5x22	2100	Clear Neutral Borosilicate Type 1 glass vials, 20mm Crimp Finish	9
CT505263C	10	Crimp	48.5x22	1680		9
CT290017C	10	Crimp	50x23.75	1512		9
CT505910B	10	Crimp	56.5x20.5	1850		9
CTB02205C	23	Crimp	59.5x29	850		9
CT505274C	50	Crimp	72x29	850		9
CTSA-23V-20T	23	Crimp	59.5x29	850	Amber Borosilicate Type 1 glass vials, 20mm Crimp Finish	10
CTSA-13V-20T	13	Crimp	50x23.75	1512		10
CT502219B	2	Screw	32x11.5	4000	Clear Borosilicate Type 1 glass vials, 8mm Screw Finish	11
CT10S.RSP00					Cap	
CT502214B	4	Screw	45x14.75	3600	Clear Borosilicate Type 1 glass vials, 13mm Screw Finish	12
CT502015B	6	Screw	44.4x19		Clear Borosilicate Type 1 glass vials, 18mm Screw Finish	13
CT502108B	11	Screw	55x22			13
CT1218SCR	12	Screw	60x20			13
CT18R					White Caps Dble Ring Seal	13
CT502105B	20	Screw	55x29		Clear Borosilicate Type 1 glass vials, 24mm Screw Finish	14
CT502215B	36	Screw	81x29			14
CT40MA	40	Screw	95x23.5			14
CT502050B	47.6	Screw	100x30			14
CT24PLP000		Caps			24mm x 400 White polypropylene caps with wadding	14
CT24S.RSP000		Caps			24mm x 400 White polypropylene ring seal caps	14
CTP24B		Caps			24mm X 400mm Black polypropylene ring seal caps	14
CTP24B - 1		Caps			24mm x 400 Black polypropylene caps with wadding	14
CT502039B	21	Screw	57.2x27	990	Clear Borosilicate Type 1 glass vials, 22mm Screw Finish	15
CT502210B	25	Screw	76x27	792		15
Catalog No	Nominal Volume	Type	Size HtxOD	Qty/Slab	Description	15
CT22RSP000		Caps			22mm White polypropylene ring seal cap	15
CT502155A	20	24 Screw	55x29		Amber Borosilicate Type 1 glass vials, 24mm Screw Finish	16
CT24PLP000	24 Cans				24mm x 400 White polypropylene caps with wadding	16

CT24S.RSP000	24 Caps			24mm x 400mm White polypropylene ring seal caps	16
CT24B	24 Caps			24mm X 400 Black polypropylene ring seal caps	16
CTP24B - 1	24 Caps			24mm x 400 Black polypropylene caps with wadding	16
Clear Neutral Borosilicate Type 1 glass					
CT461505S	2 13 Crimp	32x13.1	3710	vials, 13mm Crimp Finish	17
CTB02140S	2 13 Crimp	37.5x13.1	3680		17
CT411922	5 13 Crimp	38.5x13.1			17
CTB02171S	10 13 Crimp	45x13.1	1980		17
CTB02178S	10 13 Crimp	50x13.1	1320		17
Clear Neutral Borosilicate Type 1 glass					
CT505243S	7 20 Crimp	37.5x22.0	2100	vials, 20mm Crimp Finish	18
CT400610S	10 20 Crimp	40.5x25.5	1740		18
CT505910S	10 20 Crimp	56.5x20.5	1850		18
CTB02168S	10 20 Crimp	45x22	1980		18
CT505258S	13 20 Crimp	48.5x24	1550		18
CT415626S	20 20 Crimp	65.5x25.5	1450		18
CTB02205S	23 20 Crimp	59.5x29	850		18
CTB02213S	23 20 Crimp	65x29	850		18
CT505230S	50 20 Crimp	72x29	1130		18
Amber Neutral Borosilicate Type 1					
CTV12025S	2.5 13 Crimp	35x14.75	4250	glass vials, 13mm Crimp Finish	19
CT2513SA	2.5 13 Crimp	32x15	3710		19
Amber Neutral Borosilicate Type 1 glass					
CT720SA	7 20 Crimp	37.5x22	1446	vials, 20mm crimp finish	20
CT505263SA	7 20 Crimp	48.2x22	1584		20
CT505283TPTS	10 20 Crimp	50x24	1550		20
CT505275SA	13 20 Crimp	48.5x24	1550		20
CT505282TPTS	15 20 Crimp	57x26.6	1080		20
CT505287TPTC	20 20 Crimp	59.5x29	1130		20
Clear Neutral Borosilicate Type 1 glass					
CTB02161S	7 18 Screw	39x22	1980	vials, 18mm Screw Finish	21
CTDN2221S	13 18 Screw	60x22	1584		21
CTDN2223S	5 18 Screw	31x20.5	2960		21
CTDN2224S	7.5 18 Screw	40x27	1980		21
<b>Catalog No</b>	<b>Nominal Volume</b>	<b>Type</b>	<b>Size HtxOD</b>	<b>Qty/Slab</b>	<b>Description</b>
CT502210S	25 22 Screw		76x27		Clear Neutral Borosilicate Type 1 glass vials, 22mm Screw Finish
CTB02053S	25 22 Screw		76x27		
CTDN2225S	27 22 Screw		76x27		
CT22RSP000	22 Cap				22mm White polypropylene ring seal cap
Amber Neutral Borosilicate Type 1 glass					
CTB02158S	7 18 Screw	39x21.5	1980	vials, 18mm Screw Finish	23
Amber Neutral Borosilicate Type 1 glass					
CT502282TPTS	20 20 Screw	70x26.6	1080	vials, 20mm Screw Finish	24
CT517805C				Caps to Suit	24
Clear Borosilicate Test Tubes with Screw Finish					
CT502010B	10 15 Test Tube	15x96			25
Amber Borosilicate type 1 glass, 9mm					
CT211632A	2 9 Screw	32x12	850	Screw finish	27

CT211632C	2 8 Screw8	32x12	780	Clear Borosilicate type 1 glass, 8mm Screw finish	27
Amber Moulded Injection Vials – ISO/SFDA 20mm crimp finish Type II – Sulphur Treated & Washed					
CTPY8A - W	8 20 Crimp	46.8x23			28
CTPY10A - W	10 20 Crimp	53.5x25.4	480		28
CTPY15A - W	10 20 Crimp	53.5x25.4	660		28
CTPY20A - W	20 20 Crimp	58x32	480		28
CTPY30A - W	30 20 Crimp	62.8x36	276		28
CTPY50A - W	50 20 Crimp	73x42.5	336		28
CTPY100A - W	100 20 Crimp	94.5x51.6	198		28
Amber Moulded Injection Vials – ISO/SFDA 20mm crimp finish USP Type					
CTPY8A	8 20 Crimp	46.8x23	936	III	29
CTPY10A	10 20 Crimp	53.5x25.4	768		29
CT15A	15 20 Crimp	53.5x25.4	660		29
CTPY20A	20 20 Crimp	58x32	480		29
CTPY30A	30 20 Crimp	62.8x36	276		29
CTPY50A	50 20 Crimp	73x42.5	336		29
CTPY100A	100 20 Crimp	94.5x51.6	198		29
Clear Borosilicate Glass USP Type 1					
CT220075C	7.5	20 36.2x24.6			30
CT220102C	10	20 56.1x24.6			30
CT220101C	10 ISO/SFDA	53.5x25.4			30
CT220201C	20 ISO/SFDA	58x32			30
CT220301C	30 ISO/SFDA	62.8x36	276		30
CT220302C	30	20 26.5x27.8	276		30
CT220504C	50	20 68x46	336		30
CT220501	50 ISO/SFDA	73x42.5	336		30



Catalog No	Nominal Volume	Type	Size HtxOD	Qty/Slab	Description	Page No
CT221001C	100	ISO/SFDA	94.5x51.6	198		31
CT221004C	100	20	104x49	198		31
Clear Moulded Injection Vials – ISO/SFDA 20mm crimp finish USP Type II – Sulphur Treated & Washed						
CTPY7C - W	7	20 Crimp	40.8x22.1			32
CTPY8C - W	8	20 Crimp	46.8x23			32
CTPY10C - W	10	20 Crimp	53.5x25.4			32
CTPY15C - W	15	20 Crimp	58.8x26.5			32
CTPY20C - W	20	20 Crimp	58x32	480		32
CTPY30C - W	30	20 Crimp	62.8x36	276		32
CTPY50C - W	50	20 Crimp	73x42.5	336		32
CTPY100C - W	100	20 Crimp	94.5x51.6	198		32
Clear Moulded Injection Vials for Antibiotics Ring Finish GB19.7mm, USP Type II – Sulphur Treated & Washed						
CT120052C - W	5		38.7x22			33
CT120053C - W	7		38.7x29.5			33
CT120122C - W	12		56.8x27			33
CT120075C - W	7.5		63.2x24.6			33
CT120103C - W	10		51.1x24.6			33
CT120303C - W	30		61.5x37.8			33
CT120323C - W	32		66x33			33
CT120108C - W	10		46.5x22			33
CT120158C - W	15		45.5x29.5			33
CT120208C - W	20		60x31			33
CT120109C - W	10		55x23.8			33
CT120155C - W	15		57x26			33
CT120185C - W	18		57x30			33
Clear Moulded Injection Vials for Antibiotics Ring Finish GB19.7mm, USP Type III						
CT120052C	5		38.7x22			34
CT120053C	7		38.7x29.5			34
CT120122C	12		56.8x27			34
CT120075C	7.5		63.2x24.6			34
CT120103C	10		51.1x24.6			34
CT120303C	30		61.5x37.8			34
CT120323C	32		66x33			34
CT120108C	10		46.5x22			34
Catalog No	Nominal Volume	Type	Size HtxOD	Qty/Slab	Description	
CT120158C	15		45.5x29.5			35
CT120208C	20		60x31			35
CT120109C	10		55x23.8			35
CT120155C	15		57x26			35
CT120185C	18		57x30			35
Amber Moulded Drop Dispensing Bottles						
CTDD5A	5	18DIN	50.2x22	765	– DIN 18mm	35
CTDD10A	10	18DIN	58x24.8	768		35
CTDD15A	15	18DIN	65x28.5	420		35
CTDD20A	20	18DIN	71.5x28.7	420		35
CTDD25A	25	18DIN	75.6x31	390		35
CTDD30A	30	18DIN	78.8x33	345		35
CTDD50A	50	18DIN	92.2x37.5	264		35
CTDD100A	100	18DIN	112x44.5	140		35
18mm White polypropylene ring seal screw, tamper proof tamper evident cap						
CT18WTPE						36
18mm Black polypropylene ring seal screw, tamper proof tamper evident cap						
CT18BTPE						36

CT18WTE					18mm Black polypropylene ring seal tamper evident cap	36
CT18BTE					18mm White polypropylene ring seal tamper evident cap	36
CT18 - WT					18mm White T/E polypropylene cap with dripolator inset	36
					* Polyethylene Dripolator plug is included with cap. (High Flow or regular flow.	36
Clear Moulded Drop Dispensing Bottles						
CTDD10C	10	18DIN	58x24.8	768	– DIN 18mm	36
CTDD15C	15	18DIN	65x28.5	420		36
CTDD30C	30	18DIN	78.8x33	345		36
CTDD50C	50	18DIN	92.2x37.2	264		36
CTDD100C	100	18DIN	112x44.5	140		36
CTDD150C	150	18DIN	123x50.5			
Amber Pharma Rounds, 24mm						
CT50PLC	50		86.7.x37.87	99x100ea	Tampertel Finish	37
CT100ZTS	100		109.8x45.9	80x56ea		37
CT200ZGYA	200		136x56.6	56x50ea		37
CT500ZPB	500		183.7x75.4	45x25ea		37
24mm White tamper evident polypropylene cap (available with or without wadding)						
CT24TER						37
24mm White tamper evident Child resistant cap (available with or without wadding)						
CT24STEL						37
24mm polypropylene ring seal screw cap (available with or with wadding)						
CTP24B						37
Catalog No	Nominal Volume	Type	Size HtxOD	Qty/Slab	Description	
24mm White polypropylene ring seal screw caps (available with or without wadding)						
CT24S.RSP00						37
28mm White tamper evident polypropylene cap (available with or without wadding)						
CT28TER						37
28mm White tamper evident Child resistant cap (available with or without wadding)						
CT28TEL						37
28mm White polypropylene ring seal screw cap (available with or without wadding)						
CT28S.RSP000						37
28mm Black polypropylene ring seal screw caps (available with or without wadding)						
CTP28B						37
Amber Glass Bottles for Syrups DIN						
CTS30A	30	DIN28	57x35	300	PP 28mm	38
CTS45A	45	DIN28	76x36.3			38
CTS60A	60	DIN28	94x38.6	200		38
CTS100A	100	DIN28	104.8x46.1	140		38
CTS150A	125	DIN28	114.4x49	210		38
Clear Glass Bottles for Syrups DIN PP						
CTS30C	30	DIN28	67x35		28mm	39
CTS60C	50	DIN28	94.5x38.6			39
CTS125C	125	DIN28	114.4x49	126		39
Amber Glass Boston Round – G.P. I						
CTBR15A	1/2oz	18-400	68.3x25		400-18,20,22 mm	40
CTBR30A	1oz	20-400	78.6x32.8			40

CTBR60A	2oz	20-400	93.7x38.6	240		40
CTBR120	4oz	22-400	112.7x48.5	128		40
Amber Glass Tablet Bottles – Wide						
CT460601	60 GPI 400 - 33	75.5x44.5			Mouth GPI 400	41
CT460752	75 GPI 400 - 38	82.5x45.3				41
CT461003	100 GPI 400 - 38	87.5x50				41
CT461204	120 GPI 400 - 38	95x52.8		3780		41
CT461505	150 GPI 400 - 45	100x56				41
CT462006	200 GPI 400 - 45	109.5x61.4				41
CT462007	250 GPI 400 - 45	117.5x65.3				41
Amber Glass bottles for Syrups PP 18,						
CT420151	15 PP 18	67.5x27			20, 22mm	42
CT420301	30 PP 20	78.8x33				42
CT420601	60 PP 20	93.8x40.8		240		42
CT421201	120 PP 22	115.2x48.4		128		42
Amber Glass Bottles for Syrups Screw						
CT450501	50 PP 28	107.2x35			Finish STD PP 28mm	43
CT450752	75 PP 28	107x43				43
<b>Catalog No</b>	<b>Nominal Volume</b>	<b>Type</b>	<b>Size HtxOD</b>	<b>Qty/Slab</b>	<b>Description</b>	<b>Page No</b>
CT451003	100	PP 28	120.7x44.3			43
CT451004	100	PP 28	123.5x44.6			43
CT451005	100	PP 28	126x43.2			43
CT451006	100	PP 28	120x44.5			43
CT451007	100	PP 28	126x43.2			43
CT451008	100	PP 28	123.5x44.6			43
CT451009	100	PP 28	120.7x44.3			43
CT45150K	150	PP 28	135.5x52			43
Clear Infusion Bottles Type II , Ring						
CT210501C	50 ISO 32	68x46			Finish ISO SFDA 32mm	44
CT210508C	50	28 80x45.3				44
CT210502C	50 SFDA28.3	78x46				44
CT211003C	100	28.8 96x52				44
CT211001C	100 ISO 32	104x49				44
CT211002C	100 SFDA28.3	110x53				44
Clear Essence Bottle G.P.I 400						
CT320151	15 18-400	68.3x25				45
CT320301	30 20-400	78.6x32.8				45
CT320601	60 20-400	93.7x38.6				45
CT320302	30 PP 20	88.5x34.8				45
CT320202	20 PP 18	98.5x30				45

# MS® Sample Vials for Chromatography

11mm Crimp & Screw Cap 2ml 12x32 8-425 and 9-425



... 4ml 13-425 Screw, Headspace 20, 40, 60ml 24-425 Screw ...  
pre-cleaned VOA HS Grade ... also Available

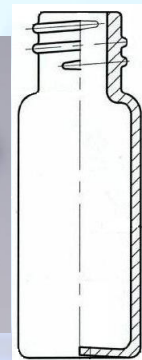
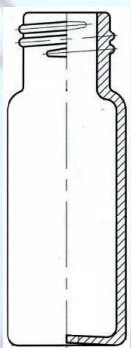

Caps and Septa available separately ... if required

## MS® Sample Vials

MS® Sample vial are made from first hydrolytical class, borosilicate glass, compliant with the requirements of U.S. and European Pharmacopeia which improves your laboratory productivity, by reducing costs and saving time. These products considerably reduce the risk of analytical test results compromised by ghost peaks, damaged needles or dislodged septa, decreasing analysis failures and sample reruns.

MS® offer Type 1, 51-expansion glass vials and type-2, 33- expansion glass vials.

### Feature

- LCGC certificate
- High quality glass Type 1, 51-expansion glass (clear and amber) and type-2, 33- expansion glass (only clear)
- Computerized camera system for quality control throughout the manufacturing process to test critical dimensions, including Height, Diameter, Bottom Thickness and Neck/Thread.
- Compatible with a wide range of HPLC, LCMS and GC Instruments
- Pre-packs including 100 vials and caps for ease and convenience in ordering
- Vials and caps and septas also available separately
- Meet standards set by governing bodies
- Tightest dimensional tolerances in industry

### Application

- HPLC instruments
- LCMS instruments
- GC instruments

### Vial Closures Guide

Available in three types: crimp, snap and screw cap.

Cap Design	Strength Design	Comments
Crimp	Excellent seal	Requires tools
Snap	Moderate seal	Fast, no tools
Screw	Excellent seal	Universal

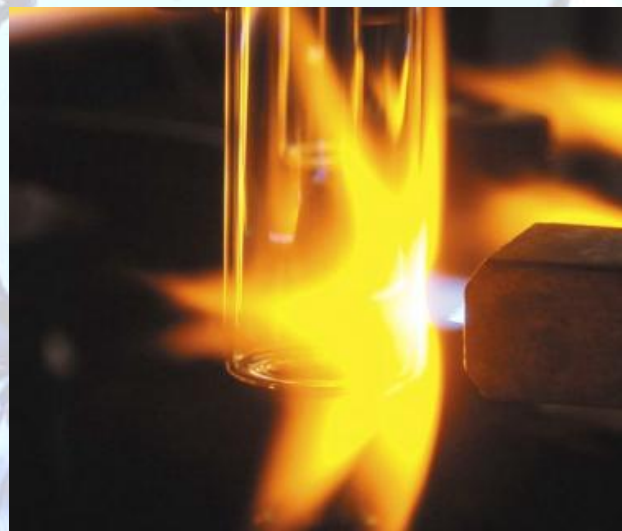
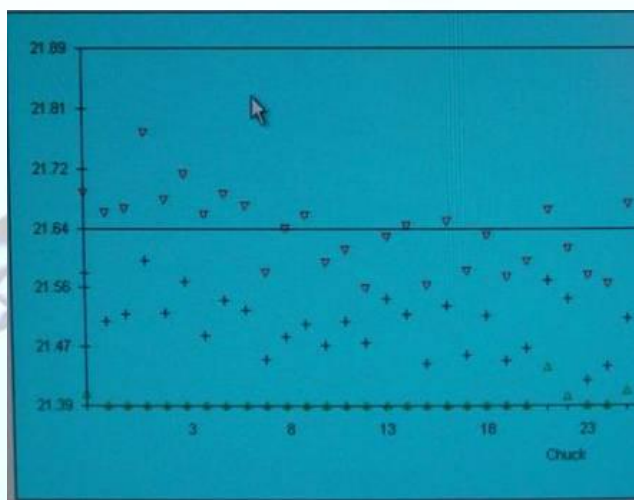
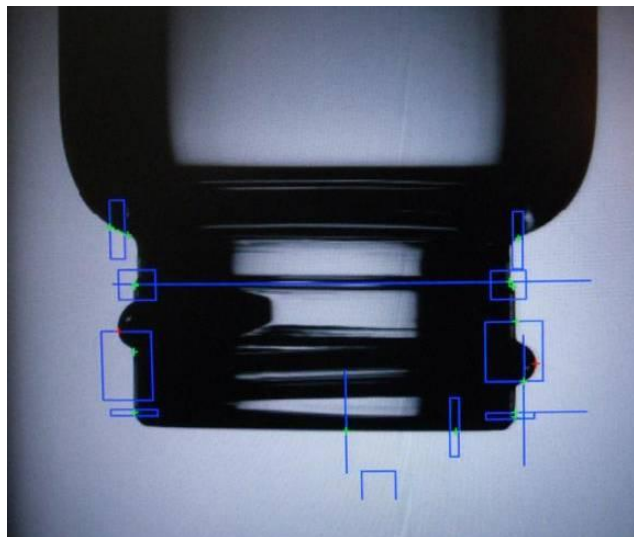

**HROMalytic** +61(0)3 9762 2034  
**ECHnology** Pty Ltd

**Australian Distributors**  
 Importers & Manufacturers  
[www.chromtech.net.au](http://www.chromtech.net.au)

Website NEW : [www.chromalytic.net.au](http://www.chromalytic.net.au) E-mail : [info@chromtech.net.au](mailto:info@chromtech.net.au) Tel: 03 9762 2034 . . . in AUSTRALIA

## Septa Selection Guide

### PTFE

- Recommended for single injection application.
- Ideal for use in MS applications
- Excellent solvent resistance and chemical compatibility
- Does not reseal upon punching
- Not for Long-term sample storage

### PTFE/Silicone

- Recommended for multiple injection and sample storage
- Excellent resealing
- PTFE chemical resistance until punctured, then will have the chemical compatibility of silicone
- Working temperature range from -40 °C to 200 °C
- Pre-slit PTFE/Silicone
- Prevent vacuum formation in vials
- Eliminates coring from bottom draw-port needles
- Good resealing capabilities
- Recommended for multiple injections
- PTFE chemical resistance until punctured, then will have the chemical compatibility of silicone
- Working temperature range from -40 °C to 200 °C



## Vials Selection Guide

- Type 1, 51-expansion borosilicate glass
- type-2, 33- expansion glass
- Deactivated glass (DV)

Treated with gas phase reactive organosilane to produce a hydrophobic glass surface. Can be stored indefinitely.

- Headspace Vials

Uniform glass thickness which insures even heat distribution for consistent sampling reliability.



**HR**OMalytic +61(0)3 9762 2034  
**ECH**nology Pty Ltd

Website NEW : [www.chromalytic.net.au](http://www.chromalytic.net.au) E-mail : [info@chromtech.net.au](mailto:info@chromtech.net.au) Tel: 03 9762 2034 . . . in AUSTRALIA

**Australian Distributors**  
Importers & Manufacturers  
[www.chromtech.net.au](http://www.chromtech.net.au)

## Ordering Information

Screw Top, Standard Opening Vials		
Part No.	Description	Unit
LBSV012C	2ml Clear vial, 8-425 screw top	100/pk
LBSV032C	2ml Clear vial, 8-425 screw top, graduated with writing area	100/pk
LBSV012A	2ml Amber vial, 8-425 screw top	100/pk
LBSV032A	2ml Amber vial, 8-425 screw top, graduated with writing area	100/pk
Screw caps - 8-425, polypropylene plastic for standard screw top vial		
LBSV012	Black screw cap with hole, for 2ml 8-425 screw top vial	100/pk
LBSV032	Blue screw cap with hole, for 2mL 8-425 screw top vial	100/pk
Septa for 8-425 Screw caps		
LBSV02RS	White PTFE/red silicone septa, for 2ml 8-425 screw top vial	10000/pk
LBSV02SS	Red PTFE/white silicone septa, for 2ml 8-425 screw top vial	10000/pk
Screw caps + Septa for standard screw top vial		
LBSV012CRS	White PTFE/red silicone septa + Black screw cap with hole, for 2ml 8-425 screw top vial	100/pk
LBSV012CSS	Red PTFE/white silicone septa + Black screw cap with hole, for 2ml 8-425 screw top vial	100/pk

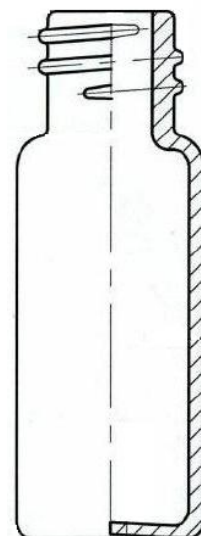

Screw Top, Wide Opening Vials		
Part No.	Description	Unit
LBSV002C	2ml Clear vial, 9-425 screw top	100/pk
LBSV022C	2ml Clear vial, 9-425 screw top, graduated with writing area	100/pk
LBSV002A	2ml Amber vial, 9-425 screw top	100/pk
LBSV022A	2ml Amber vial, 9-425 screw top, graduated with writing area	100/pk
Screw caps - 9-425, polypropylene plastic for Wide Opening screw top vial		
LBSV002	Blue screw cap with hole, for 2ml 9-425 screw top vial	100/pk
Septa for 9-425 Screw caps		
LBSV03RS	White PTFE/red silicone septa, for 2ml 9-425 screw top vial	10000/pk
LBSV03SS	Red PTFE/white silicone septa, for 2ml 9-425 screw top vial	10000/pk
LBSV23SS	Blue PTFE/white silicone septa, Pre-slit, for 2mL 9-425 screw top vial	10000/pk
Screw caps + Septa for Wide Opening screw top vial		
LBSV002CRS	White PTFE/red silicone septa + Blue screw cap with hole, for 2ml 9-425 screw top vial	100/pk
LBSV102CSS	Red PTFE/white silicone septa + Blue screw cap with hole, for 2ml 9-425 screw top vial	100/pk
LBSV222CSS	Blue PTFE/white silicone septa, Pre-slit + Blue screw cap with hole, for 2ml 9-425 screw top vial	100/pk

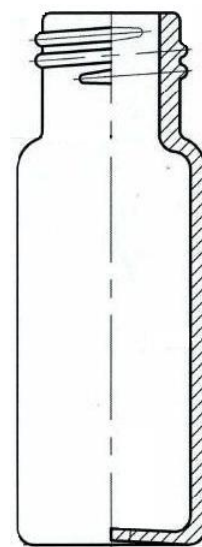

**Australian Distributors**  
 Importers & Manufacturers  
[www.chromtech.net.au](http://www.chromtech.net.au)

Website NEW : [www.chromalytic.net.au](http://www.chromalytic.net.au) E-mail : [info@chromtech.net.au](mailto:info@chromtech.net.au) Tel: 03 9762 2034 . . . in AUSTRALIA

### Crimp Top, Wide Opening Vials

Part No.	Description	Unit
LBSV042C	2ml Clear vial, crimp top	100/pk
LBSV062C	2ml Clear vial, crimp top, graduated with writing area	100/pk
LBSV042A	2ml Amber vial, crimp top	100/pk
LBSV062A	2ml Amber vial, crimp top, graduated with writing area	100/pk

### Crimp seal - aluminum cap with large hole, for crimp top vial

LBSV022	Aluminium cap 11 mm for 2ml crimp top vial	100/pk
---------	--	--------

### Septa for Crimp seal - aluminum cap

LBSV04RS	White PTFE/red silicone septa, for 2ml crimp vial	10000/pk
LBSV04SS	Red PTFE/white silicone septa, for 2ml crimp vial	10000/pk

### Aluminum cap + Septa for Wide Opening Crimp top vial

LBSV112CRS	White PTFE/red silicone septa+ Aluminium cap, for 2ml crimp top vial	100/pk
LBSV122CRS	Red PTFE/white silicone septa + Aluminium cap, for 2ml crimp top vial	100/pk

Actual DIM : Volume 1.8ml 32x11.7mm, Top ID 1/4"(6.3mm)  
Pics are to scale

Engineering Drawings available : to select Customers ONLY

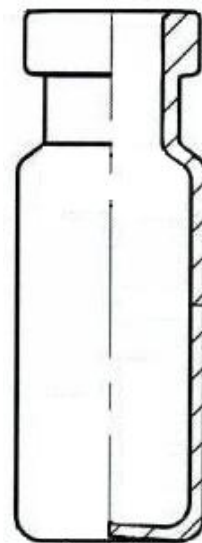

### Snap Ring Top, Wide Opening Vials

Part No.	Description	Unit
LBSV052C	2ml Clear vial, snap top	100/pk
LBSV072C	2ml Clear vial, snap top, graduated with writing area	100/pk
LBSV052A	2ml Amber vial, snap top	100/pk
LBSV072A	2ml Amber vial, snap top, graduated with writing area	100/pk

### Snap caps- for snap ring top vial with bonded-in septa

LBSV202CSS	Red PTFE/white silicone septa + Blue snap cap, for 2ml 9-425 Snap Ring Top vial	100/pk
------------	---	--------

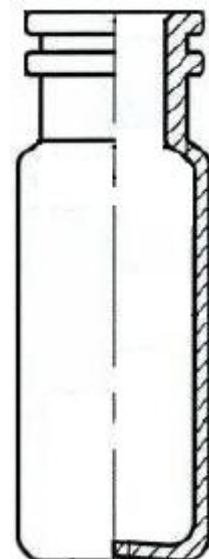

both Crimp & Screw Vials available . . .

with and without Graduations / White Marking Spot

Septa - Disc Type ( in-situ pre-moulded ) Silicone Rubber/PTFE laminated

- replacable - Silicone -Top, PTFE - Inner layer

- both red on White and White on Red



**2ml 12\*32mm Vials, flat base, clear and amber - Nominal sizes Only - designed to fit common chromatography Autosamplers**

**Standard Opening Crimp Top 8-425**      1. Narrow neck crimp top vials fit many older GC autosamplers.  
2. Compatible with all 11mm crimp seals and 5mm nominal diameter inserts

**Wide Opening Crimp Top 9-425**      1. Easier to fill  
eg Agilent Autosamplers              2. Used with either 11mm aluminum seals

**Standard Opening Screw Thread 8-425**      Standard neck vial—8-425 thread finish, 12x32mm outer profile

**Wide opening Screw Thread 9-425**      Wide neck vial is easy to fill

**11mm Snap**      1. Wide opening vial is easier to fill and provides a larger target area for the autosampler needle  
2. Used with snap caps

**4ml 15\*45mm Vials, flat base**

Screw Thread, Crimp Top, Snap Top Vials

**Headspace Vials**

Beveled Edge, Square Rim

Also Available with 10ml, 20ml, and 40ml vials.

More information please visit our website : [www.chromtech.net.au](http://www.chromtech.net.au)

Or mail : Chromalytic Technology Pty Ltd in AUSTRALIA at : [info@chromtech.net.au](mailto:info@chromtech.net.au)



**Australian Distributors**  
Importers & Manufacturers  
[www.chromtech.net.au](http://www.chromtech.net.au)

**Website NEW : [www.chromalytic.net.au](http://www.chromalytic.net.au) E-mail : [info@chromtech.net.au](mailto:info@chromtech.net.au) Tel: 03 9762 2034 . . . in AUSTRALIA**

# VIALS

Overview .....	353
Septum Selection Guide .....	353
Vial Size Quick Reference Chart .....	354-355
Crimp-Top Vials .....	356-357
Certified Vials .....	357
Screw-Thread Vials .....	358-361
WISP Vials .....	361-362
Headspace Vials .....	363
Versa Vials .....	364
VOA Sampling Vials .....	364
Micro-Vials .....	365
Interlock Vials .....	365
Vial Accessories .....	366-367



**HR**OMalytic +61(0)3 9762 2034  
**ECH**nology Pty Ltd

**Australian Distributors**  
Importers & Manufacturers  
[www.chromtech.net.au](http://www.chromtech.net.au)

Website NEW : [www.chromalytic.net.au](http://www.chromalytic.net.au) E-mail : [info@chromtech.net.au](mailto:info@chromtech.net.au) Tel: 03 9762 2034 . . . in AUSTRALIA

**Siltek® Coated Vials**

For a highly inert surface, we recommend Siltek® deactivation for your vials:

- Maximizes inertness, minimizes sample breakdown—ideal for difficult matrices and reactive compounds.
- Inert over a wide sample pH range.
- Low bleed.
- Thermally stable.

Siltek® deactivation produces a highly inert glass surface that features high temperature stability, extreme durability, and low bleed. Try Siltek® deactivated vials for better recovery of sample analytes.

For Siltek® vials, add the corresponding suffix number to the vial catalog number.

Qty.		Siltek Deactivation	
100-pk.		-222	addl. cost
1000-pk.		-223	addl. cost

**Septum Selection Guide**

Materials	Compatibility	Incompatibility	Resealability	Max. Temp.
Red Rubber (synthetic)	acetone, alcohols, DMF, DMSO, ether	ACN, benzene, chloroform, heptane, hexane, pyridine, THF, toluene	very good	90 °C
PTFE/ Natural Rubber	PTFE: resistance until punctured Rubber: acetone, ACN, alcohols, diethylamine, DMF, DMSO, phenol	aromatics, carbon disulfide, chlorinated solvents, hydrocarbon solvents	very good	90 °C
PTFE/Silicone PTFE/Silicone/PTFE	PTFE: resistance until punctured Silicone: acetone, alcohols, DMF, DMSO, ether	ACN, benzene, chloroform, heptane, hexane, pyridine, THF, toluene	very good	205 °C
Polyethylene	Good resistance to solvents and weak acids or bases. Unreactive with most chemicals, but some solvents cause softening or swelling.	hydrocarbon solvents	one-time use	175 °C
Gray Chlorobutyl	acids or bases, water solutions, buffer solutions, oxygenated solvents, vegetable oils	aliphatic or aromatic hydrocarbons, halogenated solvents, mineral oils, strong acids	very good	100 °C

Abbreviations: ACN = acetonitrile, DMF = dimethylformamide, DMSO = dimethylsulfoxide, THF = tetrahydrofuran

**NOTE:** This chemical resistance chart is intended only as a guideline. It does not cover all compounds or all solvents. Tests were done at room temperature on pure, single solvents, and there is no data on solvent combinations. Always confirm the compatibility of your vial, closure, and chemical combination prior to sample preparations.

**instrument reference****For 2.0 mL, 11 mm Crimp-Top Vials**

The following instruments are compatible with 2.0 mL, 11 mm crimp-top vials. For further information or questions, please contact your Restek sales representative or technical service.

Manufacturer	Instrument/Model #	Manufacturer	Instrument/Model #	Manufacturer	Instrument/Model #
A.I.M.	CPS -100, 200	Gilson	231 XL, 232 XL, 233 XL, Asted	Sedere	
A.I.	42 vial tray		XL, Aspec XL	Shimadzu	SIIL-10A, 10Ai, 10AxL, AOC 20i
Agilent	1042, 1050, 1080, 1082, 1084, 1090, 1100, 5890, 6850, 6890, 7670A, 7671A, 7672, 7673A/B, 7683, 7890, 8042	Gynkotech	Gina, others	Siemens	AS 32, AS 200
Alcott	738	Hitachi	AS-2000, AS-6000	Spark Holland	SPH 125, Marathon, Promis, Triathlon, Midas
Alltech	570, 580 (standard tray)	IBM		Spectra-Physics	8875, 8880
Altex		ICI	other than LC 1600	Talbot	
AMS	42	Infochroma		Thermo Scientific	TRACE GC 2000, AS2000
Antek	736 Unisampler, 738	Jasco	851-AS, AS-950	TosoHaas	TSK-6080, AS-8010, AS-8020
ASC		Kipp		Tosca 1	
Carlo Erba/	42 vial tray	Kontron	360	Tracor	770, 771, 772
Fisons	AS 800	LDC	Marathon, Promis, other than 713	TSP	8875, 8880, AS 100/1000, AS 300/3000
Carnegie	CMA-250/200	L.E.A.P. Technologies	CTC A200S, CTC A105S	Unicam	4710, LC-XR 4247
Chrompack	CP 9000 GC Series	Magnus Scientific		United Technologies	
CTC	CTC A105S	PerkinElmer	Autosystem GC, AI-1, Integral 4000, ISS 100, ISS 200, LC 600 42 vial tray, 420/B, 4900	Varian/Rainin	Dynamax AI-IA, AI-200, Dynamax AI-3
Dani	ALS 39.80, 86.80			Varian	8100/8200, 9100/9090/9095, Marathon
Delsi		Pharmacia LKB	2157-010	Waters	Alliance 2690
Dynatech	42 vial tray	Precision Sampling	GC111, GC 311, LC 241-60		
Fisons	42 vial tray, AS800	Phillips	LC-XR 4247, 4710		
GBC		Polymer-Labs	GPC 110/210		
Gerstel		Pye	LCXP		
		S.G.E.	M280D		

All vials pictured are actual size, with description, Restek catalog number, and page number for quick reference.

## WISP Vials

4.0 mL Screw-Thread Step Vial



24654, 24655  
24656, 24657  
Page 362

4.0 mL Clear Crimp-Top



24658, 24659  
Page 361

700 µL Limited Volume



24680,  
24681  
Page 362

96 Style



24662, 24663,  
24664, 24665,  
24678, 24679  
Page 362

## Headspace Vials

10 mL Clear Flat Bottom

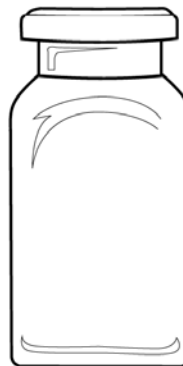

24683,  
24684  
Page 363

10 mL Clear Rounded Bottom



21164,  
21165  
Page 363

20 mL Clear Flat Bottom



24685,  
24686  
Page 363

20 mL Clear Rounded Bottom

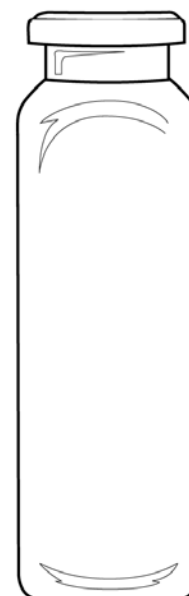

21162,  
21163  
Page 363

All vials pictured are actual size, with description, Restek catalog number, and page number for quick reference.

**Limited Volume Inserts**

250 µL Big Mouth Insert



24516, 21779  
Pages 356, 361

250 µL Glass Flat Bottom



24510  
Page 360

350 µL Glass Flat Bottom Inserts w/ID Ring

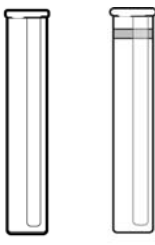

21780, 24517  
Pages 356, 361

24692, 24693  
Pages 356, 361

500 µL Glass WISP Flat Bottom



21787, 21788  
Page 362

100 µL Glass or Polypropylene w/ Polypropylene Bottom Spring



24508, 21775  
24512  
Page 360

250 µL Glass or Polypropylene w/ Bottom Spring



21776, 21777  
Pages 356, 361, 362  
24518  
Page 356

**8 mm Screw-Thread Vials**

2.0 mL Clear or Amber w/ White Graduated Marking Spot



24619, 24620, 24621, 24622  
Page 359

**9 mm Short-Cap Vials**

2.0 mL Clear or Amber w/White Graduated Marking Spot



21154\*, 21155\*  
\*w/out white graduated marking spot  
21140, 21141  
21142, 21143  
Page 358

**10 mm Screw-Thread Vials**

2.0 mL Big Mouth Step Clear or Amber



24626, 24627, 24628, 24629  
Page 360

**11 mm Crimp-Top Vials**

Limited Volume 100 µL Glass Insert, Clear Plastic Vial

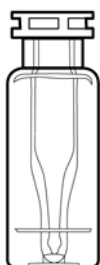

24653  
Page 356

Limited Volume 100 µL Polypropylene

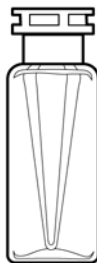

24651, 24652  
Page 356

2.0 mL Snap Seal Style Clear or Amber Glass



21152, 21153, 24383, 24384, 24385, 24386  
Page 356



24385

24383



21724

also **available**

See **page 366** for crimpers and decappers.



24673



21776

24518A

24692



24651

### 2.0 mL Crimp-Top Vials, 12 x 32 mm, 11 mm

White graduated marking spots are a standard feature unless otherwise noted.

#### 2.0 mL Crimp-Top Vials, 12 x 32 mm, 11 mm

Description	Volume	Color	Material	100-pk.	1000-pk.
Vial w/White Graduated Marking Spot	2.0mL	Clear	Glass	24383	\$18.50 24384
Vial w/White Graduated Marking Spot	2.0mL	Amber	Glass	24385	\$19.50 24386
Vial without Graduated Marking Spot	2.0mL	Clear	Glass	21152	\$16.50 21153

#### 2.0 mL, 11 mm Aluminum Crimp Seals with Septa

Seal Color	Septa Material	100-pk.	500-pk.	1000-pk.
Silver	PTFE/Natural Rubber	21174	\$13.50	— 21175
Blue	PTFE/Red Rubber	24351	\$19.50	— 24352
Green	PTFE/Red Rubber	24353	\$19.50	— 24354
Red	PTFE/Red Rubber	24355	\$19.50	— 24356
Yellow	PTFE/Red Rubber	24357	\$19.50	— 24358
Mixed	PTFE/Rubber	—	—	21724 \$50 —
Silver	PTFE/Silicone	24359	\$25.50	— 24360
Blue	PTFE/Silicone	24361	\$28	— 24362
Green	PTFE/Silicone	24363	\$28	— 24364
Red	PTFE/Silicone	24365	\$28	— 24366
Yellow	PTFE/Silicone	24367	\$28	— 24368
Mixed	PTFE/Silicone	—	—	21725 \$119.50 —
Silver	PTFE/Silicone/PTFE	24369	\$28	— 24370

#### 2.0 mL Crimp Vial Convenience Kits (Vials, Caps, & Septa)

Vials packaged in a clear-lid tray. Caps with septa packaged in a plastic bag.

Description	100-pk.	1000-pk.
Clear 2.0mL Vial, Deactivated, Silver Seal, PTFE/Natural Rubber Septa	24671	\$44 24672
Amber 2.0mL Vial, Deactivated, Silver Seal, PTFE/Natural Rubber Septa	24673	\$44 24674
Clear 2.0mL Vial, Untreated, Silver Seal, PTFE/Natural Rubber Septa	21196	\$34 21197
Amber 2.0mL Vial, Untreated, Silver Seal, PTFE/Natural Rubber Septa	21198	\$34 21199
Clear 2.0mL Vial, Untreated, Silver Seal, PTFE/Silicone Septa	24646	\$40 24647
Amber 2.0mL Vial, Untreated, Silver Seal, PTFE/Silicone Septa	24648	\$40 24649

#### Inserts

for 2.0 mL, 11 mm Crimp-Top & 2.0 mL, 9 mm Short-Cap, Screw-Thread Vials

Description	Volume	Material	100-pk.	1000-pk.
Big Mouth Insert w/Bottom Spring	50µL	Glass	24513	\$48 21782
Big Mouth Insert w/Bottom Spring	250µL	Glass	21776	\$82 21777
Big Mouth Insert w/Glass Flange (Step Design)*	250µL	Glass	24516	\$71.50 21779
Insert, Flat Bottom	350µL	Glass	21780	\$21.50 24517
Insert, Flat Bottom w/ID Ring	350µL	Glass	24692	\$23.50 24693
Big Mouth Insert w/Bottom Spring	250µL	Polypropylene	24518	\$18.50 — —
Big Mouth Insert w/Bottom Spring & Graduated Markings	250µL	Polypropylene	24518A	\$24.50 — —
Big Mouth Insert, Top Flange	250µL	Polypropylene	24519	\$11.50 — —
Big Mouth Insert, No Spring	250µL	Polypropylene	24520	\$11.50 — —

\*Not to be used with 9mm screw-thread vials.

#### 2.0 mL Crimp-Top Vial with 100 µL Insert

- Plastic vial.
- Choice of glass or polypropylene insert.

Description	100-pk.	1000-pk.
Clear Plastic Vial w/100µL Polypropylene Insert	24651	\$21.50 24652
Clear Plastic Vial w/100µL Glass Insert	24653	\$149 — —

### 2.0 mL, 11 mm Poly Crimp Seal Caps: Snap-on or Crimp

The patented Poly Crimp Seal is versatile, working as either a snap-on or crimp-top cap. Simply use a standard crimping tool to secure the Poly Crimp Seal onto any crimp-top vial. It's that easy!

- Works on any crimp style vial.
- Crimps smoothly and easily—no more sharp edges from an aluminum crimp cap.
- Easily decaps using standard decapping tools.
- Eliminates inconsistent sealing that results from improper crimping.
- Unique design holds the septum firmly in place.
- Provides better seal than snap caps.\*
- Meets CONEG standards. The Poly Crimp Seal is free of heavy metals and is easily disposed of or incinerated.

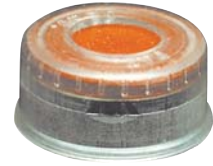

Seal Color	Liner Material	100-pk.		400-pk.		1000-pk.	
Clear	PTFE/Butyl Rubber	24433	\$18.50	—	—	24434	
Clear	PTFE/Silicone	24443	\$30	—	—	24444	
Blue	PTFE/Silicone	24445	\$30	—	—	24446	
Clear	PTFE/Silicone/PTFE	24453	\$30	—	—	24454	
Blue	PTFE/Silicone/PTFE	24455	\$35	—	—	24456	
Mixed	PTFE/Silicone/PTFE	—	—	21728	\$93	—	—

\*Based on continual use for 3–4 days.

### tech tip

#### Compatibility concerns?

Refer to the Septum Selection Guide on page 353.

### 2.0 mL, 11 mm GC Snap Ring Cap with Septum

- Snaps on any crimp-style vial.
- Clear polypropylene cap provides a tighter seal than standard Snap Ring Cap.
- Good for pressurized injection systems.
- Save money! Use this snap cap when you don't need to crimp.

Description	Liner/Septa Material	100-pk.		1000-pk.	
Polypropylene Snap-Top Cap w/Liner	PTFE, 10mil	21729	\$20.50	21730	
Polypropylene Snap-Top Cap w/Septum	PTFE/Butyl Rubber	21731	\$23.50	21732	
Polypropylene Snap-Top Cap w/Septum	PTFE/Silicone	21733	\$30	21734	



21731

### Certified Autosampler Vial Kits

#### Certified Vials, 2.0 mL Screw-Thread Vials

National Scientific's certified vial kits provide the extra assurance that time after time the vial you use conforms to the rigorous manufacturing standards of National Scientific. These certified vial kits include your choice of vials and closures, conveniently packaged in benchtop storage compartments.

- Certificates enclosed with each kit.
- Vials of clear or amber borosilicate glass, with ID marking spots.
- Closures with pre-inserted septa.
- Each kit sealed for integrity.

#### Certification Parameters Include:

Vial Dimensions:	height, diameter, bottom thickness, neck length, thread profile, and annealing
Cap/Septum:	diameter, height, thread integrity, center flash, septa insertion, sealing/resealing test, residue by headspace GC, and extractables
Chemical Test:	HPLC Test: nonvolatile residue GC Test: volatile residue



22788



22792

Description	100-pk.
Assembled Clear 2.0mL Vial w/Marking Spot, Cap, Bonded PTFE/Silicone Slit Septa	22789
Assembled Amber 2.0mL Vial w/Marking Spot, Cap, Bonded PTFE/Silicone Slit Septa	22788
Unassembled Clear 2.0mL Vial w/Marking Spot, Cap, Bonded PTFE/Silicone Septa	22792
Unassembled Amber 2.0mL Vial w/Marking Spot, Cap, Bonded PTFE/Silicone Septa	22790
Unassembled Clear 2.0mL High Recovery Vial w/Marking Spot, Cap, Bonded PTFE/Silicone Slit Septa	22793
Unassembled Amber 2.0mL Vial w/Marking Spot, Cap, Bonded PTFE/Silicone Slit Septa	22791

Agilent Compatible!



21140

Ideal for Agilent 7673 & other autosamplers that process 12 x 32 mm crimp-top vials.

### 2.0 mL, 9 mm Short-Cap, Screw-Thread Vials, 12 x 32 mm

- Fit all 2.0 mL, 12 x 32 mm, crimp-top vial based autosamplers.
- Shorter screw cap allows the robotic autosampler to function properly.
- Wider opening prevents syringe problems.
- Dimensions are effectively identical to the crimp-top vial.
- Variety of colors and liner material.

Are you tired of dealing with crimp-top vials, but worried about using screw-thread vials with your autosampler? If you want the performance of a crimp-top vial with the convenience of a screw-thread vial, these vials are the answer for you.

### 2.0 mL, 9 mm Short-Cap, Screw-Thread Vials (vial only)

Description	Volume	Color	100-pk.	1000-pk.
Short-Cap Vial w/White Graduated Marking Spot	2.0mL	Clear	21140	21141
Short-Cap Vial w/White Graduated Marking Spot	2.0mL	Amber	21142	21143
Short-Cap Vial without Graduated Marking Spot	2.0mL	Clear	21154	21155

### 2.0 mL, 9 mm Short-Cap, Screw-Vial Closures (Polypropylene, preassembled)

Cap Color	Liner Material	100-pk.	500-pk.	1000-pk.
Blue	PTFE/Red Rubber	24473	—	24474 \$170.50
Mixed	PTFE/Red Rubber	—	24668	—
Blue	PTFE/Silicone	24485	—	24486
Green	PTFE/Silicone	24487	—	24488
Yellow	PTFE/Silicone	24493	—	24494
Mixed	PTFE/Silicone	—	24669	—
Blue	PTFE/Silicone/PTFE	24497	—	24498
Black	PTFE/Silicone/PTFE	24495	—	24496
Natural	PTFE/Silicone/PTFE	24501	—	24502
Red	PTFE/Silicone/PTFE	24503	—	24504
Yellow	PTFE/Silicone/PTFE	24505	—	24506
Mixed	PTFE/Silicone/PTFE	—	24670	—



also available

Limited Volume Inserts

for 2.0 mL, 9mm Short-Cap, Screw-Thread Vials  
See page 356.

### instrument reference

#### For 2.0 mL, 9 mm Short-Cap, Screw-Thread Vials

The following instruments are compatible with 2.0 mL, 9 mm short-cap, screw-thread vials. For further information or questions, please contact your Restek sales representative or technical service.

Manufacturer	Instrument/Model #	Manufacturer	Instrument/Model #
Carlo Erb/Fisons	AS 800	L.E.A.P. Technologies	CTC A200S
Dani	ALS 39.80, 86.80	PerkinElmer	AI-1, ISS 100, ISS 200, LC 600 42 vial tray
Dynatech	42 vial tray, LC2000	Shimadzu	SIL-10A, 10Ai, 10Axi
Gilson	231 XL, 232 XL, 233 XL, Aspec XL	Spark Holland	SPH 125, Marathon, Promis
Agilent	1042, 1050, 1080, 1082, 1084, 1090, 1100, 5890, 6890, 7670A, 7671A, 7672, 7673A/B, 7683, 7890, 8042	Spectra-Physics	8875, 8880
Hitachi	AS-2000, AS-6000	Thermo Scientific	TRACE GC 2000, AS2000
LDC	Marathon, Promis	Varian	8100/8200, Marathon
		Waters	Alliance 2690

### 2.0 mL Sample Vial Racks

- Racks feature alphanumeric indexing for easier vial identification.
- Racks can be stacked for efficient storage.
- Fits most 2.0 mL, 12 x 32 mm vials (vials sold separately).



Description	Capacity	qty.	cat.#	price	qty.	cat.#	price
Polypropylene Storage Rack for 12 x 32mm Vials	50 vials, 5 x 10	ea.	22856		5-pk.	22857	



## 2.0 mL Screw-Thread Vials, 12 x 32 mm, 8 mm/425 Thread

- Fit all 2.0 mL, 12 x 32 mm, screw-thread 8 mm/425 vial-based autosamplers.
- Vaporization is minimized over shorter vials.

### 2.0 mL, 8 mm Screw-Thread Vials (vial only)

Description	Volume	Color	100-pk.	1000-pk.
Vial w/White Graduated Marking Spot	2.0mL	Clear	24619	24620
Vial w/White Graduated Marking Spot	2.0mL	Amber	24621	24622

### 2.0 mL, 8 mm Caps and Septa (preassembled)

Cap Color	Septa Material	100-pk.	1000-pk.
Black	Red PTFE/Silicone, 0.065"	21149	21720
Black Top Hat	PTFE/Silicone	21721	21722

### Caps & Septa

for 2.0 mL, 8 mm Screw-Thread Vials

Description	Septa Material	100-pk.	1000-pk.
Black Polypropylene, Open-Hole Caps		21176	21177
Septa, 8mm x 0.045"	Red PTFE/Silicone	21178	21179
Septa, 8mm x 0.065"	Red PTFE/White Silicone	21795	21147

### 2.0 mL Autosampler Vial Convenience Kits

- Vials packaged in a clear-lid tray. Preassembled caps with septa packaged separately in a plastic bag.
- Black polypropylene open-hole caps and 8 mm red PTFE/silicone septa, 0.065".

Description	100-pk.	1000-pk.
Clear 2.0mL Vial, Silcote CL7-Deactivated, Black Cap, Red PTFE/Silicone Septa, 0.065"	24638	24639
Amber 2.0mL Vial, Silcote CL7-Deactivated, Black Cap, Red PTFE/Silicone Septa, 0.065"	24640	24641
Clear 2.0mL Vial, Untreated, Black Cap, Red PTFE/Silicone Septa, 0.065"	21192	21193
Amber 2.0mL Vial, Untreated, Black Cap, Red PTFE/Silicone Septa, 0.065"	21194	21195

### 2.0 mL Preassembled Vial Kits

8 mm/425 Screw-Thread, Unmarked Vials, Septa, and Caps

Caps attached to vials.

Description	100-pk.	1000-pk.
Clear 2.0mL Vial, Black Cap, Red PTFE/Silicone Septa, 0.045"*	24630	24631
Amber 2.0mL Vial, Black Cap, Red PTFE/Silicone Septa, 0.045"*	24632	24633
Clear 2.0mL Vial, Black Cap, Red PTFE/Silicone Septa, 0.065"**	24634	24635
Amber 2.0mL Vial, Black Cap, Red PTFE/Silicone Septa, 0.065"**	24636	24637

\*Best fit for Shimadzu.

\*\*Best fit for Varian.





also available

Limited Volume Inserts  
for 2.0 mL, 8mm Screw-Thread Vials  
See page 360.

## instrument reference

### For 2.0 mL, 8 mm Screw-Thread Vials

The following instruments are compatible with 2.0 mL, 8 mm screw-thread vials. For further information or questions, please contact your Restek sales representative or technical service.

Manufacturer	Instrument/Model #	Manufacturer	Instrument/Model #
A.I.M.	CPS-100, 200	PerkinElmer	Autosystem GC, 420/B, 4900
Alcott	738	Pharmacia LKB	2157-010
Alltech	570	Precision Sampling	GC111, GC 311, LC241-60
ASC		Phillips	LC-XP, 4247, 4710
Beckman	501, 502, 507	S.G.E.	M2800
Carlo Erba/Fisons	AS 800, 8000	Sedere	
Dani	ALS 39.80, 86.80	Shimadzu	AOC-8B/9, SIL-6A, AOC14/1400, AOC-17, SIL-6B, -9A, -8A, SIL-10A, 10Ai, 10AxL
Dynatech	42 vial tray	Spark Holland	Marathon, Promis, Tiathalon, Midas
Gilson	231XL, 232XL, 233XL, Asted XL, Aspec XL	Spectra-Physics	8875, 8880
Gynkoteck	Gina, others	Talbot	
Hitachi	S6551, L-7200, L-7250	TOA	ICA5450
IBM		TosoHaas	TSK-6080, AS-8010, AS-8020
ICI	All except LC1600	TSP	8875, 8880, AS100/1000, AS300/3000
Infochroma		Unicam	4700LC, LC-XP, 4247
Jasco	851-AS, AS-950, LC800 & 900 series	United Technologies	
Kipp		Varian/Rainin	Dynamax AI-3AI-IA, AI-2W
Kontron	360, 460	Varian	8100/8200, 8035, 8000 Series, Marathon, 8055, 8085, 9100/9090/9095, 3800 GC
LDC	All except 713	Waters	Alliance 2690
L.E.A.P. Technologies	CTC A200S		
Magnus Scientific			



24623



24626



24677



21148

### Inserts for 2.0 mL, 8 mm Screw-Thread Vials

Description	Volume	Material	100-pk.	1000-pk.
Insert w/Polypropylene Bottom Spring	100µL	Glass	24508	21775
Insert, Flat Bottom	250µL	Glass	—	24510
Insert, Flat Bottom w/ID Ring	250µL	Glass	—	24691
Insert, No Spring	100µL	Polypropylene	24511	—
Insert w/Bottom Spring	100µL	Polypropylene	24512	—

### 2.0 mL, 8 mm Screw-Thread Vials with 100 µL Insert

- Plastic vials.
- Choice of glass or polypropylene insert.

Description	100-pk.	1000-pk.
Plastic Vial w/100µL Polypropylene Insert	24623	24624
Plastic Vial w/100µL Glass Insert	24625	—

\*Amber glass insert/clear plastic vial available on request (1,000-packs only).

### 2.0 mL Big Mouth Step Design Screw-Thread Vials, 12 x 32 mm, 10 mm/425 Thread

- 40% larger opening than other vials.
- Step profile automatically centers glass flange limited volume inserts.
- Preassembled caps with septa, with or without vials.
- Designed for Waters Alliance® autosamplers.

The Big Mouth Step Vial System has a larger ID than conventional vials and incorporates a neck finish that is uniquely designed to allow the insert to be precisely aligned in the center of the vial. This precise alignment provides maximum sample withdrawal and eliminates any chance of missed injections.

### 2.0 mL Big Mouth Step Screw-Thread Vials (vial only)

Description	Volume	Color	100-pk.	1000-pk.
Big Mouth Step Vial w/White Graduated Marking Spot	2.0mL	Clear	24626	24627
Big Mouth Step Vial w/White Graduated Marking Spot	2.0mL	Amber	24628	24629

### Caps and Septa for 2.0 mL Big Mouth Step Vials

Description	Septa Material	1000-pk.
Caps and Septa, Preassembled	PTFE/Silicone/PTFE, 0.040"	21723
Caps and Septa, Preassembled	Red PTFE/White Silicone, 0.060"	24677
Septa Only	Red PTFE/White Silicone, 0.060"	21148

### also available

See page 361 for preassembled vial kits and limited volume inserts.

### tech tip

#### Compatibility concerns?

Refer to the Septum Selection Guide on page 353.

### instrument reference

#### For 2.0 mL, 10 mm Screw-Thread Vials

The following instruments are compatible with 2.0 mL, 10 mm screw-thread vials. For further information or questions, please contact your Restek sales representative or technical service.

Manufacturer	Instrument/Model #
Alcott	738
Alltech	570
Altex	
ASC	
Beckman	501, 502, 507
L.E.A.P. Technologies	CTC A200S
Shimadzu	SIL-10A, 10Ai, 10AxL, AOC-20i
Varian	8100/8200
Waters	Alliance 2690

**Preassembled Vial Kits and Limited Volume Inserts for 2.0 mL Big Mouth Step Design Screw-Thread Vials, 12 x 32 mm, 10 mm/425 Thread**

**2.0 mL Big Mouth Step Vial Kits w/Black Caps (preassembled)**  
Caps attached to vials.

Description	100-pk.	1000-pk.
Clear 2.0mL Vial, Black Cap, PTFE/Silicone/Red PTFE Septa, 0.040"	24675	24676
Clear 2.0mL Vial, Black Cap, Red PTFE/Silicone Septa, 0.065"	24642	24643
Amber 2.0mL Vial, Black Cap, Red PTFE/Silicone Septa, 0.065"	24644	24645

**Inserts**  
for 2.0 mL Big Mouth Step Design Screw-Thread Vials

Description	Volume	Material	100-pk.	1000-pk.
Big Mouth Insert w/Bottom Spring	250µL	Glass	21776	21777
Insert, Flat Bottom	350µL	Glass	21780	24517
Insert, Flat Bottom w/ID Ring	350µL	Glass	24692	24693
Big Mouth Insert w/Glass Flange (Step Design)*	250µL	Glass	24516	21779

Polypropylene inserts available on request (1,000-packs only).  
\*Not to be used with 9mm screw-thread vials.



**WISP Vials**

**4.0 mL WISP 48 Crimp-Top 13 mm Vials, 15 x 45 mm, Snap Seal**

**4.0 mL WISP 48 Crimp-Top Vial (vial only)**

Description	Volume	Color	100-pk.	1000-pk.
WISP 48 Snap Seal Vial w/White Graduated Marking Spot	4.0mL	Clear	24658	24659

**Aluminum Seals w/Septa**  
for 4.0 mL WISP Crimp-Top Vials

Seal Color	Septa Material	100-pk.	1000-pk.
Silver	PTFE/Natural Rubber	21753	21754
Silver	PTFE/Silicone	21755	21756



also **available**  
See **page 362** for inserts.

instrument **reference**

**For 4.0 mL WISP 48 Style Vials**

The following instruments are compatible with 4.0 mL WISP 48 style vials. For further information or questions, please contact your Restek sales representative or technical service.

Manufacturer	Instrument/Model #	Manufacturer	Instrument/Model #
Bruker	LC 51	TosoHaas	TSK-6080, AS-8010, AS-8020
Hitachi	L-7200, L7250	Unicam	LC-XP
Phillips	LC-XP	Waters	48-pos. M700, 710, 717+
Shimadzu	AOC-14/1400, AOC-17, SIL-2AS		



24654

### 4.0 mL WISP 48 Screw-Thread Step Vials (15 x 45 mm, 13/425)

#### 4.0 mL WISP 48 Screw-Thread Step Vials (vials only)

Description	Volume	Material	100-pk.	1000-pk.
WISP 48 Step Vial w/White Graduated Marking Spot	4.0mL	Clear	24654	24655
WISP 48 Step Vial w/White Graduated Marking Spot	4.0mL	Amber	24656	24657

#### 4.0 mL WISP 48 Caps and Septa

Description	Septa Material	100-pk.	1000-pk.
WISP 48 Caps and Septa, Top Hat	PTFE/Silicone	21745	21746
WISP 48 Caps and Septa, Preassembled	Red PTFE/Silicone, 0.065"	21743	21744
WISP 48 Caps, Black Polypropylene, Open-Hole		21741	21742
Septa	Red PTFE/Silicone/PTFE, 0.040"	21751	21752
Septa	Red PTFE/Silicone, 0.060"	21749	21750

#### Inserts

for 4.0 mL WISP 48 Screw-Thread Step Vials

Description	Volume	Material	100-pk.	1000-pk.
Insert for WISP 48 Vials, Flat Bottom**	500µL	Glass	21787	21788

Polypropylene inserts available on request (1,000-packs only).

\*\*Also fit 4.0mL Snap Seal Vials. See page 361.



24662

24664

24678

### 1.0 mL WISP 96 Style Shell Vials, 8 x 40 mm

Available in 3 styles.

#### 1.0 mL WISP 96 Style, 8 x 40 mm Shell Vials

Description	Volume	Color	Material	200-pk.	1000-pk.
WISP 96 Style Vial	1.0mL	Clear	Glass	24662	24663
WISP 96 Style Vial	1.0mL	Amber	Glass	24664	24665
WISP 96 Style Vial	1.0mL	Clear	Polypropylene	24678	24679
WISP 96 Style Vial	700µL Limited Volume	Clear	Polypropylene	24680	24681

8mm Starburst Plugs sold separately.



21769

21773

#### 8 mm Starburst Plugs

for Shell Vials, 1.0 mL, WISP 96 Style, 8 x 40 mm

Description	Color	Material	200-pk.	1000-pk.
Starburst Snap Plugs for Shell Vials	Clear	Polyethylene	21769	21770
Starburst Snap Plugs for Shell Vials, Conical	Clear	Polyethylene	21771	21772
Starburst Snap Plugs for Shell Vials, Silicone-Lined	Clear	Polyethylene	21773	21774

#### Limited Volume Inserts

for Shell Vials, 1.0 mL, WISP 96 Style, 8 x 40 mm

Description	Volume	Material	100-pk.	1000-pk.
Big Mouth Insert w/Bottom Spring	250µL	Glass	21776	21777



21776

### did you know?

Siltek® coated vials create a highly inert surface for your testing purposes, making them inert to most organics. See page 353 for more details.

### instrument reference

#### For 1.0 mL WISP 96 Style Vials

The following instruments are compatible with 1.0 mL WISP 96 style vials. For further information or questions, please contact your Restek sales representative or technical service.

Manufacturer	Instrument/Model #
Hitachi	L-7200
Waters	96-position M-700, 710, 717+

### Crimp-Top and Screw-Top Headspace Vials

- 6, 10, 20, and 27 mL vials available with 20 mm crimp-seal finish.
- 10 and 20 mL screw-top vials available with 18 mm screw-thread finish.
- Compatible with Gerstel and CTC/Leap Technologies headspace samplers when used with magnetic closures.

### Screw-Thread Headspace Vials (18 mm)

Description	Volume	Color	Dimensions	100-pk.	1000-pk.
Headspace Vial	10mL	Clear	22 x 45mm	23084	23085
Headspace Vial	10mL	Amber	22 x 45mm	23088	23089
Headspace Vial	20mL	Clear	22 x 75mm	23082	23083
Headspace Vial	20mL	Amber	22 x 75mm	23086	23087

Caps not included.



### Magnetic Screw-Thread Caps (18 mm)

Description	Septa Material	100-pk.	1000-pk.
Magnetic Caps and Septa	PTFE/Silicone	23090	23091
Magnetic Caps and Septa	PTFE/Silicone for SPME	23092	23093
Magnetic Caps and Septa	PTFE/Red Chlorobutyl	23094	23095



18 mm magnetic screw-thread caps

### Headspace Crimp Vials (20 mm)

Description	Volume	Color	Dimensions	100-pk.	1000-pk.
a) Headspace Vial	6mL	Clear	22 x 38mm	21166	21167
b) Headspace Vial, Flat Bottom	10mL	Clear	23 x 48mm	24683	24684
c) Headspace Vial, Rounded Bottom	10mL	Clear	23 x 48mm	21164	21165
d) Headspace Vial, Flat Bottom	20mL	Clear	23 x 75mm	24685	24686
e) Headspace Vial, Rounded Bottom	20mL	Clear	23 x 75mm	21162	21163
f) Headspace Vial	27mL	Clear	30 x 60mm	21160	21161

Vial to instrument compatibility are designated in instrument reference chart. below.



### Aluminum Seals w/Septa (20 mm, preassembled)

Description	Seal Color	Septa Material	100-pk.	1000-pk.
Seals w/Septa	Silver	PTFE/Gray Butyl Rubber	21761	21762
Seals w/Septa	Silver	PTFE/Silicone	21763	21764
Pressure Release Seals w/Septa	Silver	PTFE/Gray Butyl Rubber	21765	21766
Pressure Release Seals w/Septa	Silver	PTFE/Silicone	21767	21768
Magnetic Caps w/Septa, with 5mm Hole		Tan Teflon/White Silicone	22833	22832
Magnetic Caps w/Septa, with 8mm Hole		Tan Teflon/White Silicone	22831	22834
Magnetic Caps w/Septa, with 8mm Hole		PTFE/Butyl	22835	22836

5mm hole is compatible with the following systems: Carlo Erba HS500/HS800, CTC 500, Fisons HS500/HS800 and Varian/Chrompack 9020/25. 8mm hole is compatible with the Combi Pal.

### tech tip

#### Compatibility concerns?

Refer to the Septum Selection Guide on page 353.

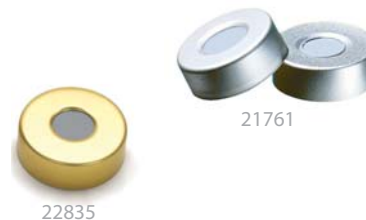

22835

21761

## instrument reference

### For Headspace Crimp Vials

The following instruments are compatible with the headspace vials listed above (as letter designated above). For further information or questions, please contact your Restek sales representative or technical service.

Manufacturer	Instrument/Model #	Manufacturer	Instrument/Model #	Manufacturer	Instrument/Model #	Manufacturer	Instrument/Model #
<b>a)</b> Carlo Erba	HS 500, HS 800	<b>c)</b> A.I.	Headspace	<b>d)</b> A.I.	Headspace	<b>e)</b> Dani	HSS 39.50, HSS 86.50, SPT 37.50
Agilent	Headspace	Cueni	Headspace	Carlo Erba	HS 500, HS 800	L.E.A.P.	Technologies HS 500
PerkinElmer	ISS 200	Dani	HSS 39.50, HSS 86.50	CTC	Headspace	PerkinElmer	Autosystem GC, F40, F45, HS 6, Integral 4000, HS 40
		L.E.A.P.		Cueni	Headspace	Tekmar	7000, 7000/7050
<b>b)</b> A.I.	Headspace	Technologies	HS 500	Dani	HSS 39.50, HSS 86.50, SPT 37.50	Varian	Genesis
Carlo Erba	HS500, HS 800	PerkinElmer	Autosystem GC, F40, F45, HS 6, Integral 4000, HS 40	Agilent	Headspace		
Cueni	Headspace	Tekmar	7000, 7000/7050	<b>e)</b> A.I.	Headspace	<b>f)</b> Shimadzu	HSS-2B
Dani	HSS 39.50, HSS 86.50	Varian	Genesis	Cueni	Headspace		
Agilent	Headspace						



22701

### 2.0 mL Versa Vials™, Glass, 12 x 32 mm

- Increased neck length for accommodating fluctuations in robotic arm settings.
- Eliminate cracked necks, breakage, and dangerous sharp edges, using soft Versa Vial PTFE/silicone plugs.
- Largest target area available, ideal for sampling and pipet use.
- Vials available with or without graduated marking spots.
- Patent pending.

Description	Volume	Color	Material	100-pk.	1000-pk.
Versa Vial	2.0mL	Clear	Glass	22701	22702
Versa Vial	2.0mL	Amber	Glass	22697	22704
Versa Vial w/Graduated Marking Spot	2.0mL	Clear	Glass	22703	22704



22705

### 1.5 mL Versa Vials™, Polypropylene, 12 x 32 mm

Description	Volume	Color	Material	100-pk.	1000-pk.
Versa Vial	1.5mL	Clear	Polypropylene	22705	22706



22707

### Versa Vial™ Inserts

Description	Volume	Material	100-pk.	1000-pk.
Versa Vial Insert w/Glass Flange	250µL	Glass	22707	—
Versa Vial Insert w/Flange	250µL	Polypropylene	22709	22710
Versa Vial Insert, Flat Bottom	250µL	Glass	22711	22712



22715

### Versa Vial™ Plugs (12 mm)

Description	Color	Plug Material	100-pk.	1000-pk.
Versa Vial Plug	Green	Polyethylene	22713	22714
Versa Vial Plug	Grey	Chlorobutyl/Siliconized	22715	22716
Versa Vial Plug	White	PTFE/Silicone	22717	22718
Versa Vial Plug	White	PTFE/Silicone Plug w/Slit*	22719	22720

\*Eliminates needle damage to plug.



21798

26122

### Pre-Cleaned Volatile Organic Analyte (VOA) Sampling Vials

- Container, liner, and closure cleaned and assembled.
- Clear or amber.
- Open top caps.
- Teflon® faced 0.125" silicone septa.
- Each case lot numbered.

Description	Volume	Color	Material	Screw-		cat.#	price
				Thread Size	qty.		
Precleaned VOA Vials	20mL	Clear	Glass	24mm/400	72-pk.	21798	
Precleaned VOA Vials	20mL	Amber	Glass	24mm/400	72-pk.	21799	
Precleaned VOA Vials	40mL	Clear	Glass	24mm/400	72-pk.	21796	
Precleaned VOA Vials	40mL	Amber	Glass	24mm/400	72-pk.	21797	
Collection Vials for ASE 200	60mL	Clear	Glass	24mm/400	72-pk.	26121	
Collection Vials for ASE 200	60mL	Amber	Glass	24mm/400	72-pk.	26122	
Replacement Septa for 20, 40 & 60mL Vials and 250mL Bottles, 24mm x 0.125"			Teflon-lined silicone		100-pk.	24694	

### Micro-Vials with Screw Threads

- Two sizes available.
- Tapered for high recovery of contents.
- Work with Mininert® sampling valves.

Description	Volume	Screw Thread Size	qty.	cat.#	price
Micro-Vial, Open Top Cap (attached), Borosilicate Glass, w/Graduated Marking Spot	1.0mL	13mm/425	12-pk.	21050	
Micro-Vial, Open Top Cap (attached), Borosilicate Glass, w/Graduated Marking Spot	3.0mL	20mm/400	12-pk.	21051	



21050

21051

### Mininert® Precision Sampling Valves for Vials

Mininert® valves are very convenient for repetitive sampling and limit content exposure to the silicon septum. Models are available for screw and crimp-top vials. The crimp-top valve for 20 mm ID glassware slides into the neck of the vial. Turn the threaded flange to secure a tight fit.

Description	Type	Thread Size	qty.	cat.#	price
Mininert Precision Sampling Valves	Screw-Thread	13mm/425	12-pk.	24900	
Mininert Precision Sampling Valves	Screw-Thread	15mm/425	12-pk.	24901	
Mininert Precision Sampling Valves	Screw-Thread	18mm/400	12-pk.	24902	
Mininert Precision Sampling Valves	Screw-Thread	20mm/400	12-pk.	24903	
Mininert Precision Sampling Valves	Screw-Thread	24mm/400	12-pk.	24904	
Mininert Precision Sampling Valves	Crimp-Top	—	12-pk.	24905	
Replacement Septa			50-pk.	24906	
Septum Insertion Tool			ea.	24907	



24903

24900

24905

### Interlock Vials

Interlock limited volume vials offer the performance and convenience of a one piece microvial for a fraction of the cost. A 300 µL insert is fused into a 12 x 32 mm clear or amber glass vial. This one piece design reduces the potential for contamination.

Description	Type	Volume	Color	Material	100-pk.	500-pk.
Interlock Vial	9mm Thread	300µL	Clear	Glass	22433	22434
Interlock Vial	9mm Thread	300µL	Amber	Glass	22435	22436
Interlock Vial	11mm Crimp or Snap Ring	300µL	Clear	Glass	22437	22438
Interlock Vial	11mm Crimp or Snap Ring	300µL	Amber	Glass	22439	22440



22433

22435

also available

See pages 356-358 for caps.



Universal plug set for battery charger included in all kits.

### Electronic Rechargeable Crimpers and Decappers

- Easy to use; comfortable grip.
- Hundreds of operations from one charge.
- Adjustable crimping force.
- New battery allows for faster charge cycle.
- All kits include a universal plug set for the battery charger.
- For 11 mm and 20 mm caps.
- One-year warranty.

The redesigned electronic crimpers and decappers have a 4.8 volt battery installed. The battery allows for quick, powerful operation and a faster charge cycle, minimizing down-time. Charging the battery takes thirty minutes to two hours. The universal plug set includes U.S., European, UK, and Australian plug clips. Each kit includes a tool, a 4.8 volt battery, which allows for a faster charge cycle, and a universal plug set for the battery charger.

### Capping

Easily crimp caps on standard crimp vials.



### Decapping has never been easier!

one...

two...

three!



Description	Size	qty.	cat.#	price
Electronic Crimper	11mm	kit	22338	
Electronic Crimper	20mm	kit	22339	
Electronic Decapper	11mm	kit	22340	
Electronic Decapper	20mm	kit	22341	
Replacement Battery for Electronic Crimpers and Decappers		ea.	22342	

Safer than removing caps with pliers, knives, or screwdriver blades!



Crimper



Decapper

### Easy Grip Manual Crimpers and Decappers

Our new Easy Grip Crimpers and Decappers feature tough, light glass-filled plastic bodies with curved handles, which improve hand comfort during use. The bottom-pull handle allows for a steadier hold than top-push handles. An easily viewed adjustment knob is located at the head of the product. The clearly shown + and - symbols, along with directional arrows, simplify adjusting the intensity of the crimp/decap needed. The knob is also designed to indicate when the crimp setting has been reached, when it fully contacts the body of the product.

Description	Size	qty.	cat.#	price
Crimper	11mm	ea.	23396	
Decapper	11mm	ea.	23397	
Crimper	20mm	ea.	23398	
Decapper	20mm	ea.	23399	



**No more burned fingers!**



### The Claw and The Claw Holder Kit

- Easily removes hot liners from injection ports.
- 4 mL vials (not included) can be replaced when dirty.

Never again will you have to burn your fingers removing a hot injection port liner. The Claw safely and cleanly removes liners, O-rings, or other small objects from the injection port. You can then place the hot objects in a clean 4 mL vial situated in the Claw holder until ready for reuse.

Description	qty.	cat. #	price
The Claw	ea.	26261	
The Claw Holder Kit (includes The Claw and holder)	kit	26262	
WISP 48 Snap Seal Vial	100-pk.	24658	

### 2.0 mL Sample Vial Racks

- Racks feature alphanumeric indexing for easier vial identification.
- Racks can be stacked for efficient storage.
- Fits most 2.0 mL, 12 x 32 mm vials (vials sold separately).

Description	Capacity	qty.	cat.#	price	qty.	cat.#	price
Polypropylene Storage Rack for 12 x 32mm Vials	50 vials, 5 x 10	ea.	22856	\$17.50	5-pk.	22857	



*Just for You*

## Custom Standards

Restek is your #1 source for custom reference standards!

- **Made to your specifications.**
- **Quick quotations.**
- **Most reference standards shipped within 15 working days.**
- **The more you buy, the more you save.**

[www.restek.com/solutions](http://www.restek.com/solutions)